

WT65 FR

GİZLİ KANATLI KAPI ve PENCERE SİSTEMİ

HIDDEN SASH DOOR & WINDOW SYSTEM

A	ISI HESAPLARI ve PERFORMANS THERMAL CALCULATIONS and PERFORMANCE	A-01 / A-05
B	CAM MONTAJ TALİMATI GLAZING ASSEMBLY	B-01 / B-04
C	ALUMİNYUM PROFİLLER ALUMINIUM PROFILES	C-01 / C-04
D	PVC PROFİLLER PVC PROFILES	D-01
E	CONTALAR GASKETS	E-01 / E-02
F	AKSESUARLAR ACCESSORIES	F-01 / F-02
G	TAM ÖLÇEKLİ PROFİLLER FULL SCALE PROFILES	G-01 / G-13
H	PRENSİP SİSTEM DETAYLARI PRINCIPAL SECTIONS	H-01 / H-12
I	ÜRETİM TALİMATLARI MANUFACTURING INSTRUCTIONS	I-01 / I-22

WT65 FR
GİZLİ KANATLI KAPI ve PENCERE SİSTEMİ
HIDDEN SASH DOOR & WINDOW SYSTEM

THERMAL HESAPLAR ve PERFORMANS
THERMAL CALCULATIONS and
PERFORMANCE

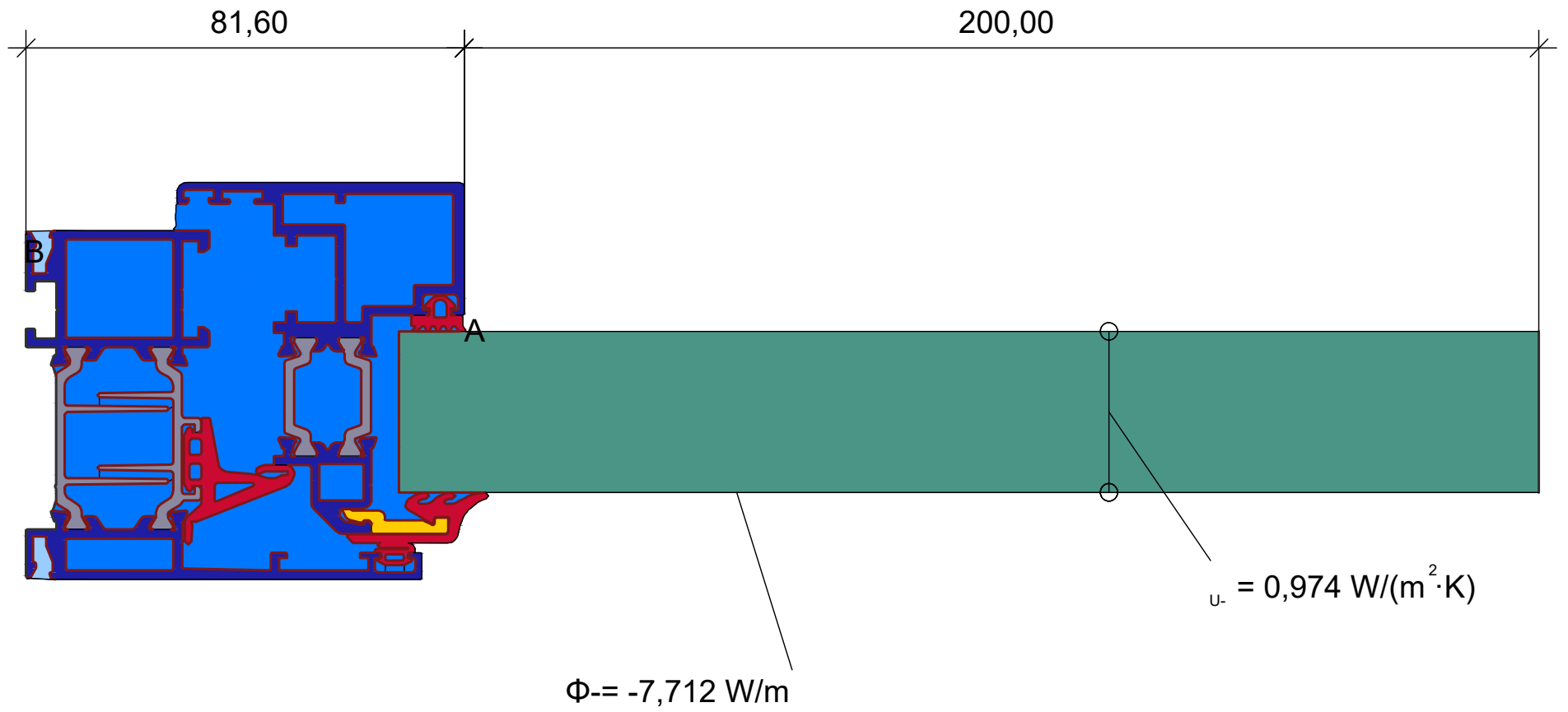

$$U_{f A,B} = \frac{\frac{\Phi}{\Delta T} \cdot b_p}{b_f} = \frac{\frac{7,712}{20,000} - 0,974 \cdot 0,200}{0,082} = 2,34 \text{ W/(m} \cdot \text{K)}$$

Material	λ [W/(m·K)]	ϵ	Boundary Condition	q [W/m ²]	θ [C°]	R [(m·K)/W]	ϵ
Aluminium (Si Alloys)	160,000	0,900	Epsilon 0.9				0,900
EPDM (ethylene propylene diene monomer)	0,250	0,900	Exterior, frame	0,000		0,040	
PVC (polyvinylchloride), rigid	0,170	0,900	Interior, frame, normal	20,000		0,130	
Panel	0,035	0,900	Interior, frame, reduced	20,000		0,200	
Polyamid 6.6 with 25% glass fibre	0,300	0,900	Symmetry/Model section	0,000			
Slightly ventilated air cavity	anisotropic						
Unventilated air cavity	anisotropic						

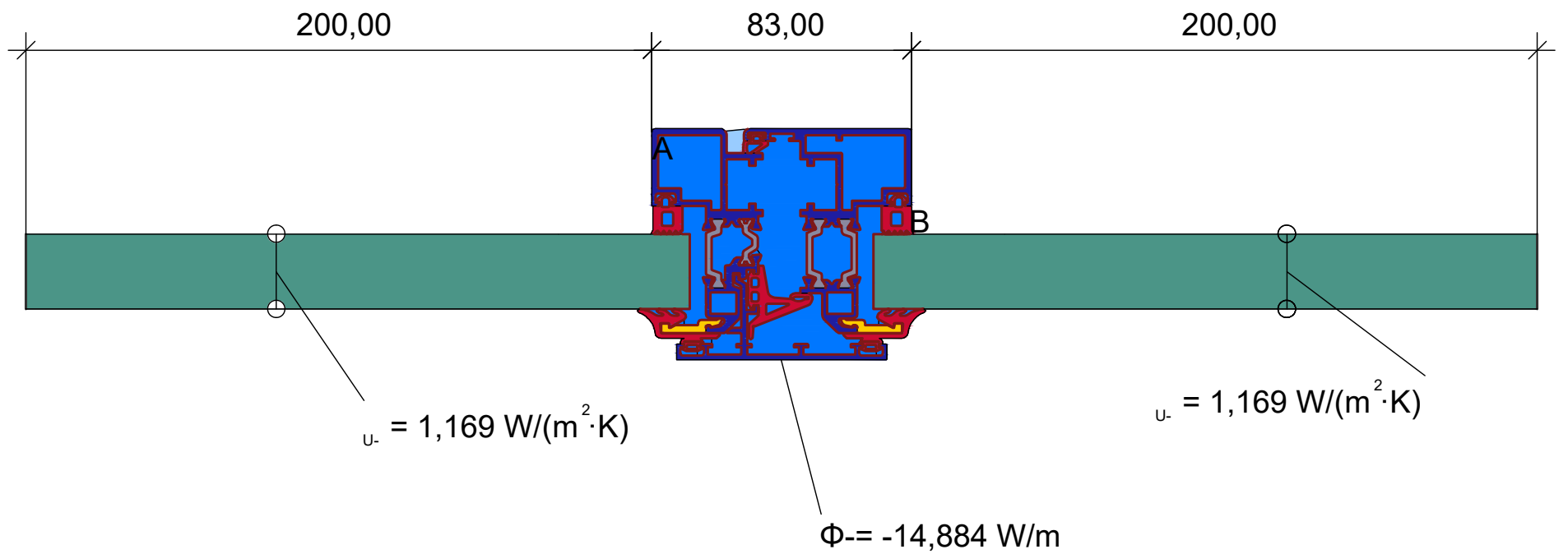

$$U_{f,A,B} = \frac{\Phi}{\Delta T} = \frac{14,884}{20,000 - 1,169 \cdot 0,200 - 1,169 \cdot 0,200} = \frac{14,884}{0,083} = 3,33 \text{ W/(m}^2 \cdot \text{K)}$$

Material	λ [W/(m·K)]	ϵ	Boundary Condition	q [W/m ²]	θ [C°]	R [(m·K)/W]	ϵ
Aluminium (Si Alloys)	160,000	0,900	Epsilon 0.9				0,900
EPDM (ethylene propylene diene monomer)	0,250	0,900	Exterior, frame	0,000		0,040	
PVC (polyvinylchloride), rigid	0,170	0,900	Interior, frame, normal	20,000		0,130	
Panel	0,035	0,900	Interior, frame, reduced	20,000		0,200	
Polyamid 6.6 with 25% glass fibre	0,300	0,900	Symmetry/Model section	0,000			
Slightly ventilated air cavity	anisotropic						
Unventilated air cavity	anisotropic						

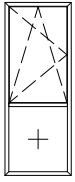
TEST ÜNİTESİ test specimen	hava geçirgenlik air permeability	su sızdırmazlık watertightness	rüzgar dayanım resist.to wind	RAPOR NO report no
	CLASS 4 600pascal EN12207	CLASS 6B 250pascal EN12208	Class C2/B2 800pascal EN12210	AVRASYA TTM 15-003637-PR03 PB-A01-02-en-02

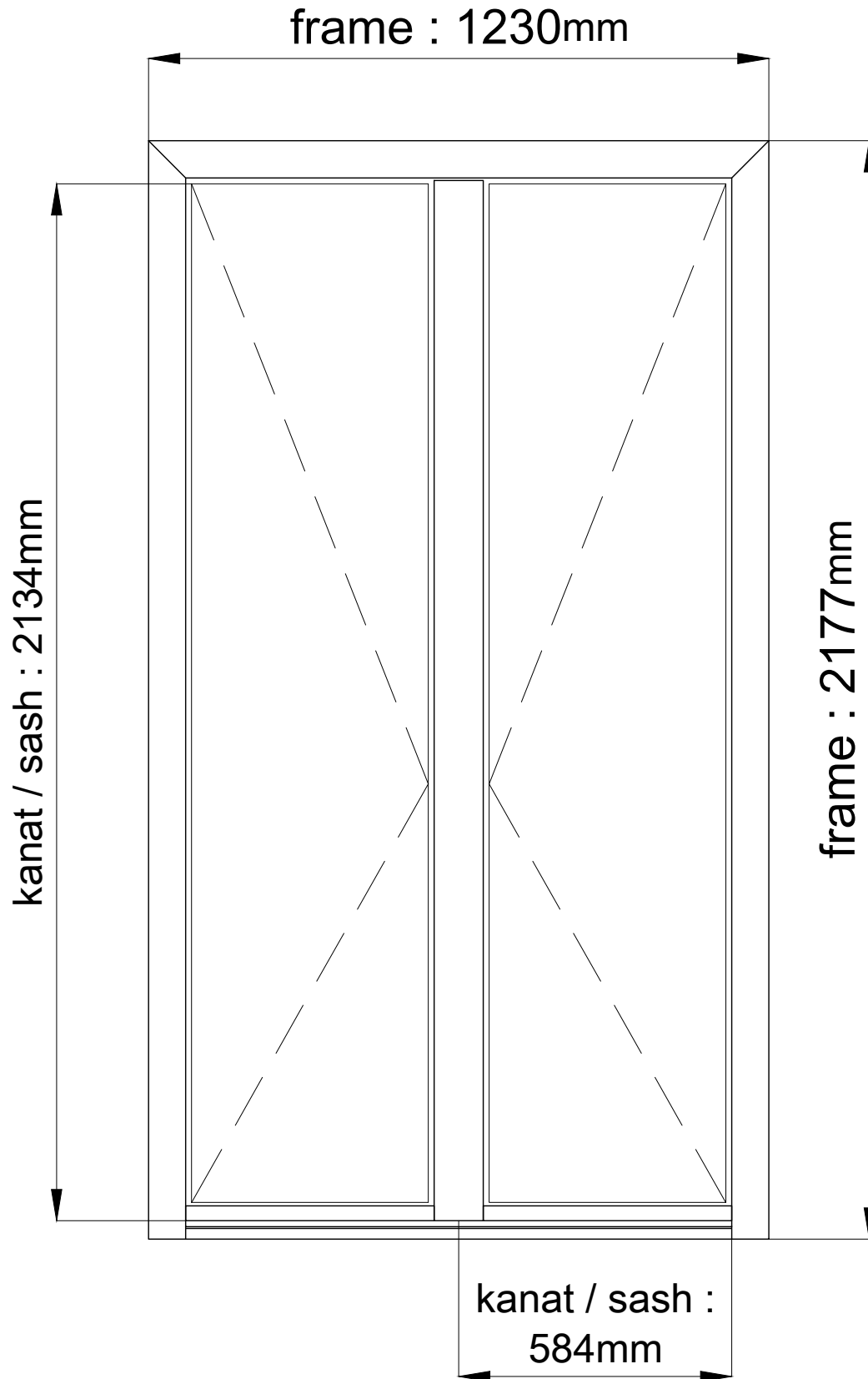

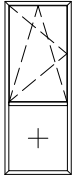
TEST ÜNİTESİ test specimen	hava geçirgenlik air permeability	su sızdırmazlık watertightness	rüzgar dayanım resist.to wind	RAPOR NO report no
	CLASS 4 600pascal EN12207	CLASS 7B 300pascal EN12208	Class C2/B2 800pascal EN12210	AVRASYA TTM 15-003637-PR02 PB-A01-02-en-01

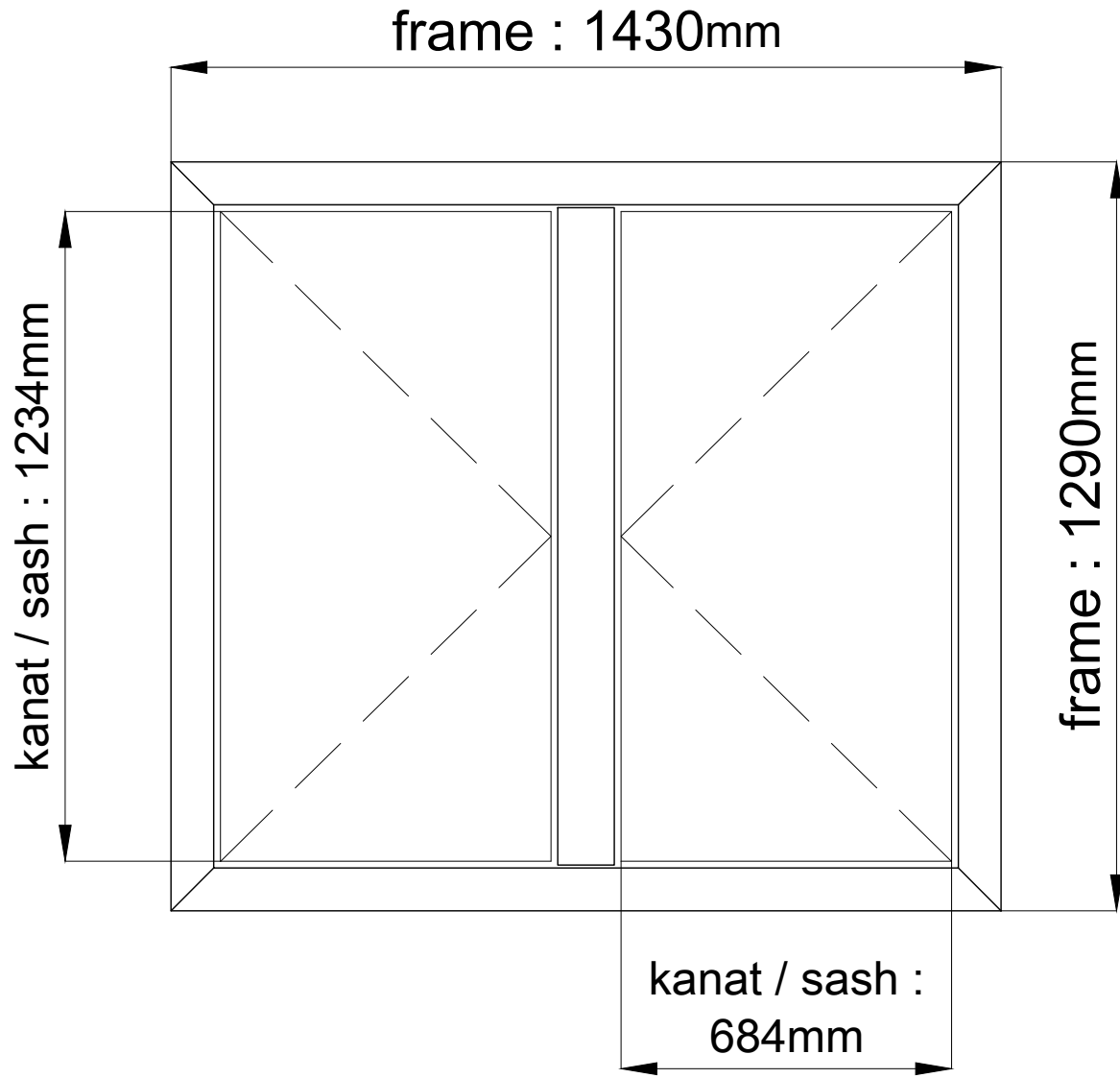

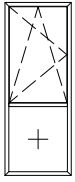
TEST ÜNİTESİ test specimen	hava geçirgenlik air permeability	su sızdırmazlık watertightness	rüzgar dayanım resist.to wind	RAPOR NO report no
	CLASS 4 600pascal EN12207	CLASS 7B 300pascal EN12208	Class C2/B2 800pascal EN12210	AVRASYA TTM 15-003637-PR01 PB-A01-02-en-01

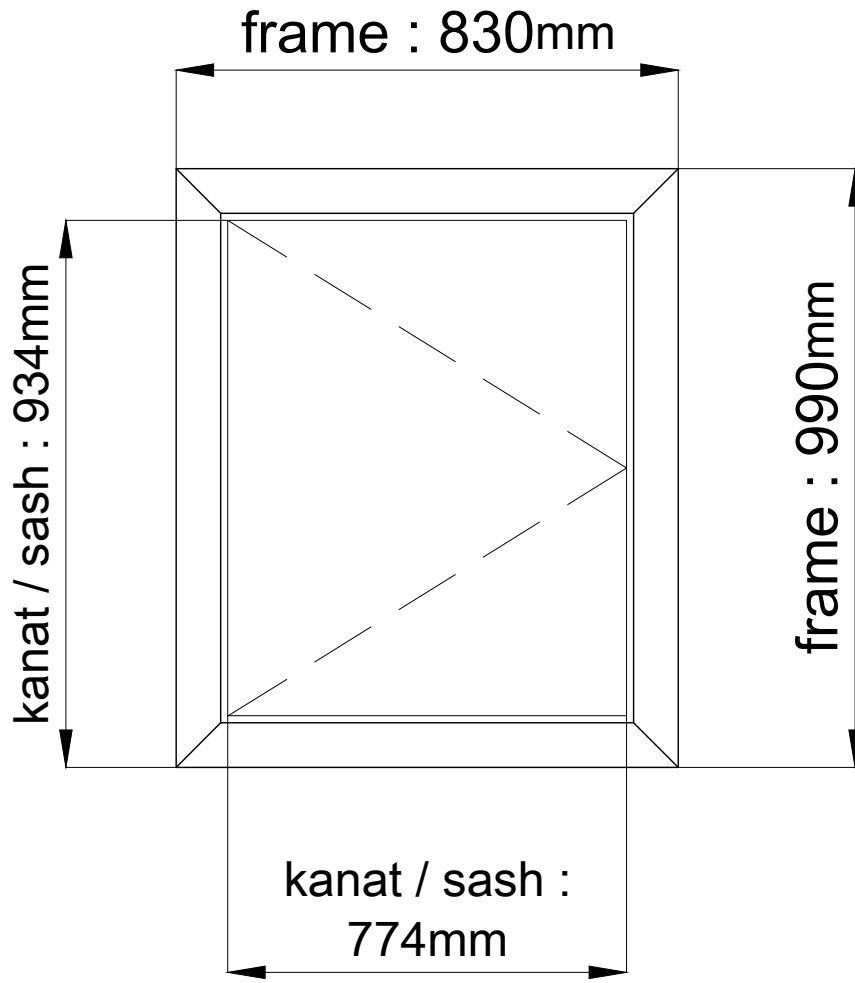

WT65 FR
GİZLİ KANATLI KAPI ve PENCERE SİSTEMİ
HIDDEN SASH DOOR & WINDOW SYSTEM

CAM MONTAJ TALİMATI
GLAZING ASSEMBLY

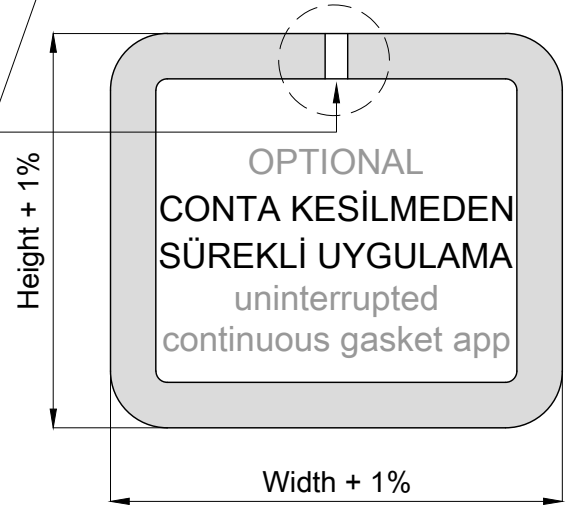
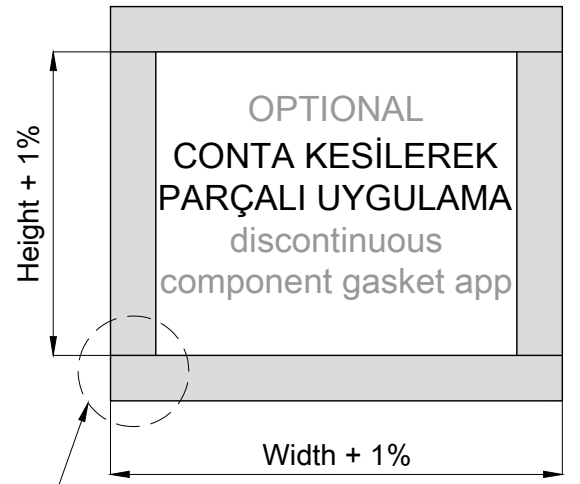
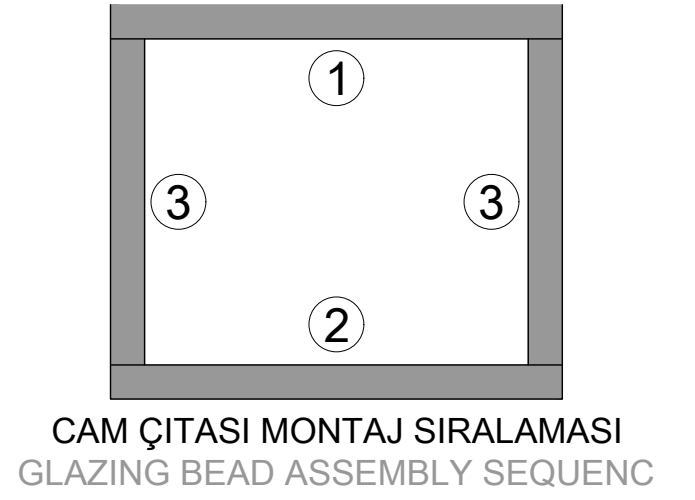
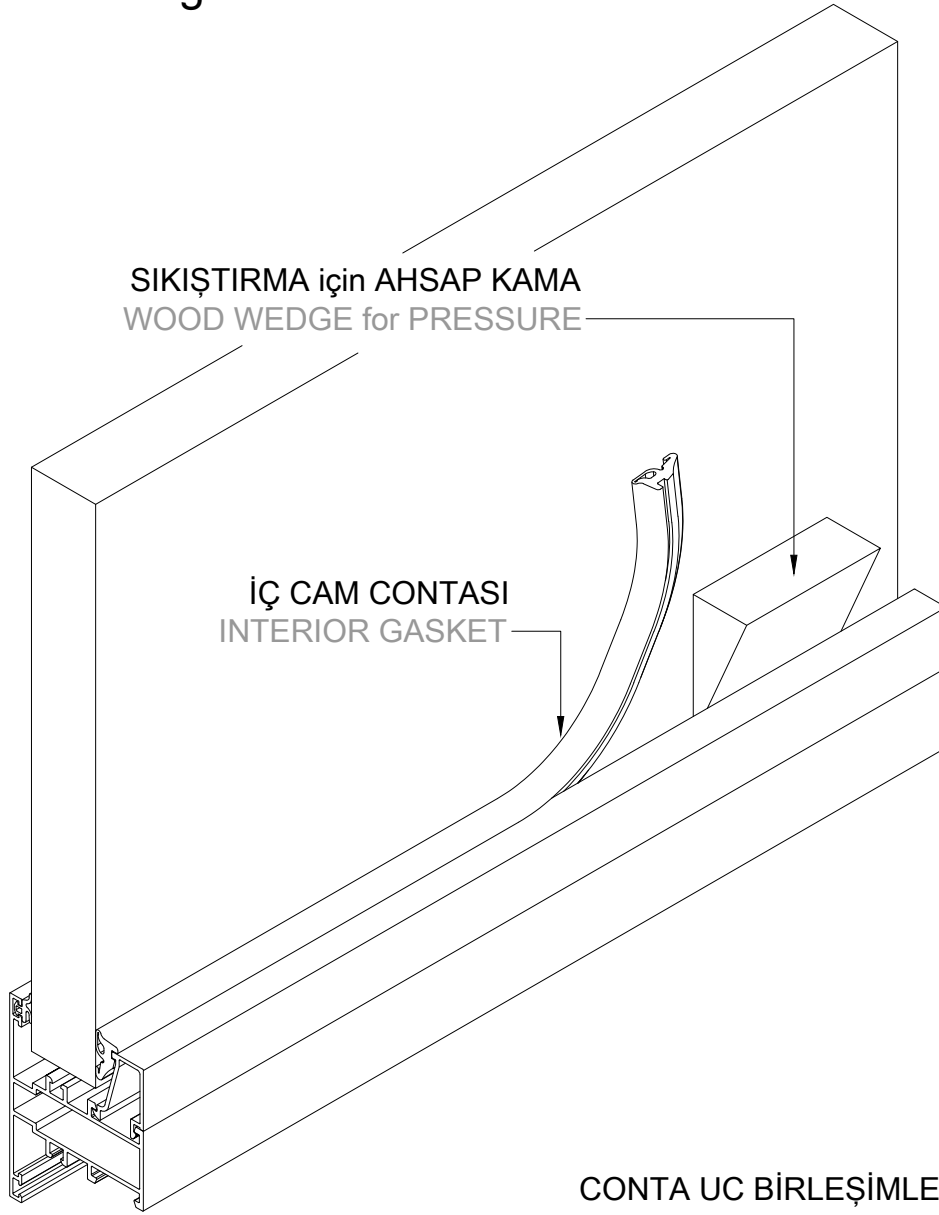

CONTA UC BİRLEŞİMLERİ ÜSTTE
OLMALI ve UYGUN MASTİK İLE
YAPIŞTIRILMALI
GASKET JOINT ON THE TOP,
BOND WITH EPDM GLUE.

1 CAM TAKOZU

Cam takozlari yerlesimi altta bulunan sematik çizimde gösterilmiştir.
takozlari kenara mesafeleri kanat ölçüsünün 5/1 i yada 10/1 i kadar olmalıdır.

GLASS CLEATS

The assembly of glass reinforcement pieces has been showed at the top schemetically. The gap distance to the corner should be, the 5/1 or 10/1 of the sash size.

2 MESAFE AYARLAMA TAKOZU

Mesafe ayar takozlari camin alüminyum çerçeve içinde doğru pozisyonda stabil olarak durmasını sağlar.
cam ile profil arasına takozlari zorlamadan yerleştiriniz.

DISTANCE ADJUSTMENT PIECE

Distance adjustment pieces stabilize the glass in the frame at the true position. Put the distance adjustment piece between glass and profile without using force.

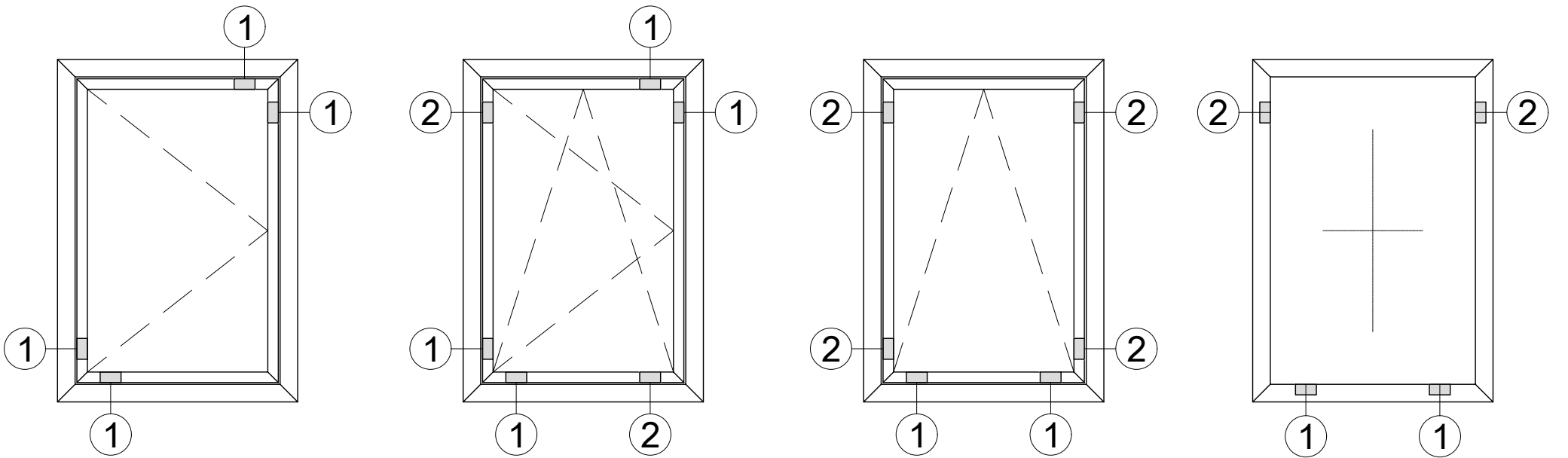

AKSESUAR ve DONANIM MONTAJINDAN ÖNCE,
CAM ve TAKOZLAMA İŞLEMİ YAPILMALIDIR.

THE PANE MUST BE SHIMMED IN THE SASH SO THAT THE SASH
OPERATES WITHOUT ADJUSTMENT OF THE HARDWARE.

1 TAŞIYICI TAKOZ
GLASS CLEAT

2 AYAR TAKOZU
ADJUSTMENT PIECE

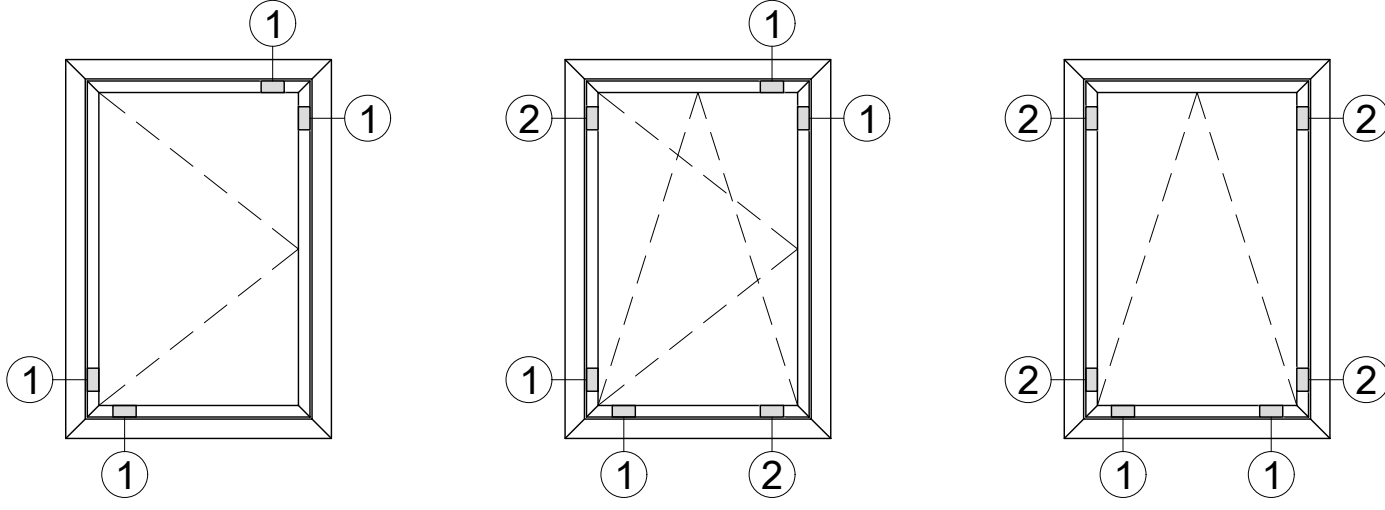

- ① **CAM TAKOZU**
Cam takozlari yerlesimi altta bulunan sematik çizimde gösterilmiştir. takozların kenara mesafeleri kanat ölçüsünün 5/1 i yada 10/1 i kadar olmalıdır.
GLASS CLEATS
The assembly of glass reinforcement pieces has been showed at the top schemetically. The gap distance to the corner should be, the 5/1 or 10/1 of the sash size.
- ② **MESAFE AYARLAMA TAKOZU**
Mesafe ayar takozlari camin alüminyum çerçeve içinde doğru pozisyonda stabil olarak durmasını sağlar. cam ile profil arasına takozlari zorlamadan yerleştiriniz.
DISTANCE ADJUSTMENT PIECE
Distance adjustment pieces stabilize the glass in the frame at the true position. Put the distance adjustment piece between glass and profile without using force.

Altta tablodaki veriler teoriktir.
Lütfen cam ve conta toleranslarını dikkate alınız.
selection tables promise a first planning.
Please keep the glass and gasket tolerances in mind.

AKSESUAR ve DONANIM MONTAJINDAN ÖNCE,
CAM ve TAKOZLAMA İŞLEMİ YAPILMALIDIR.
THE PANE MUST BE SHIMMED IN THE SASH
SO THAT THE SASH
OPERATES WITHOUT ADJUSTMENT OF
THE HARDWARE.

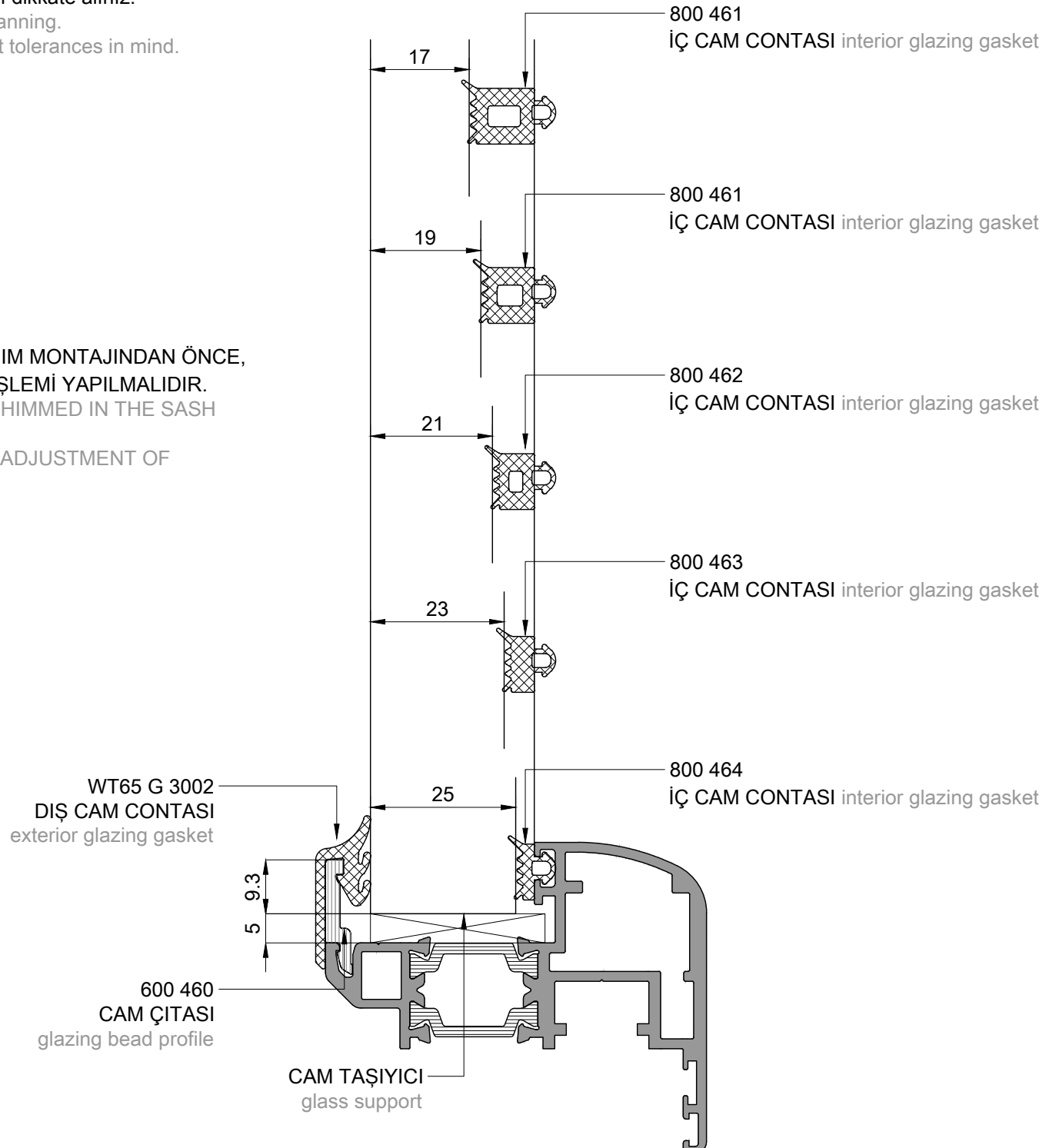

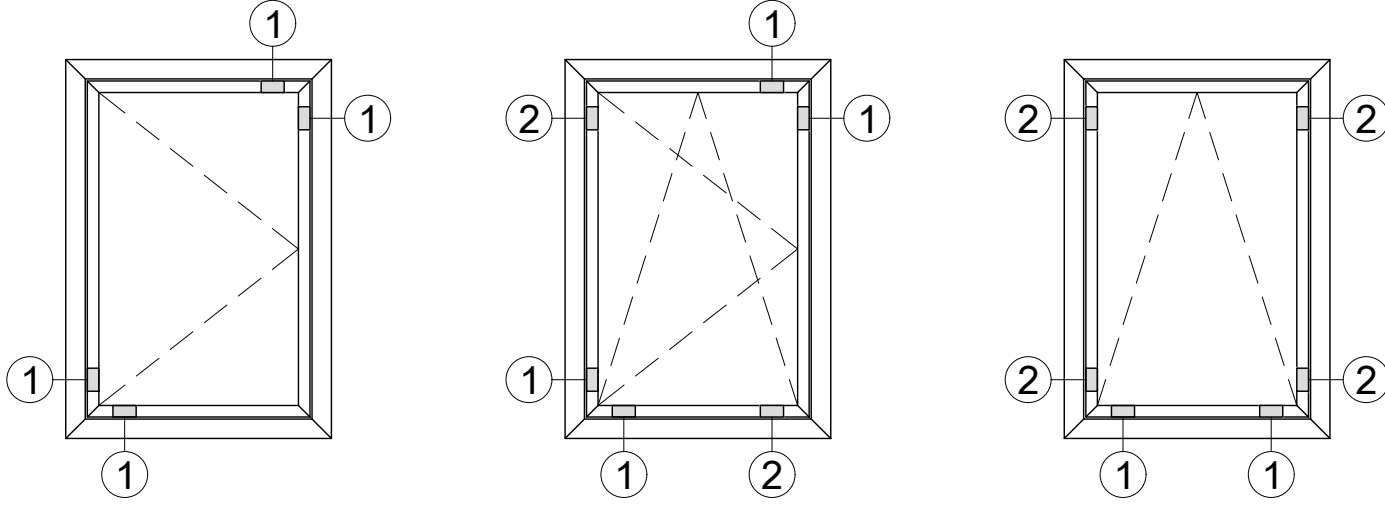







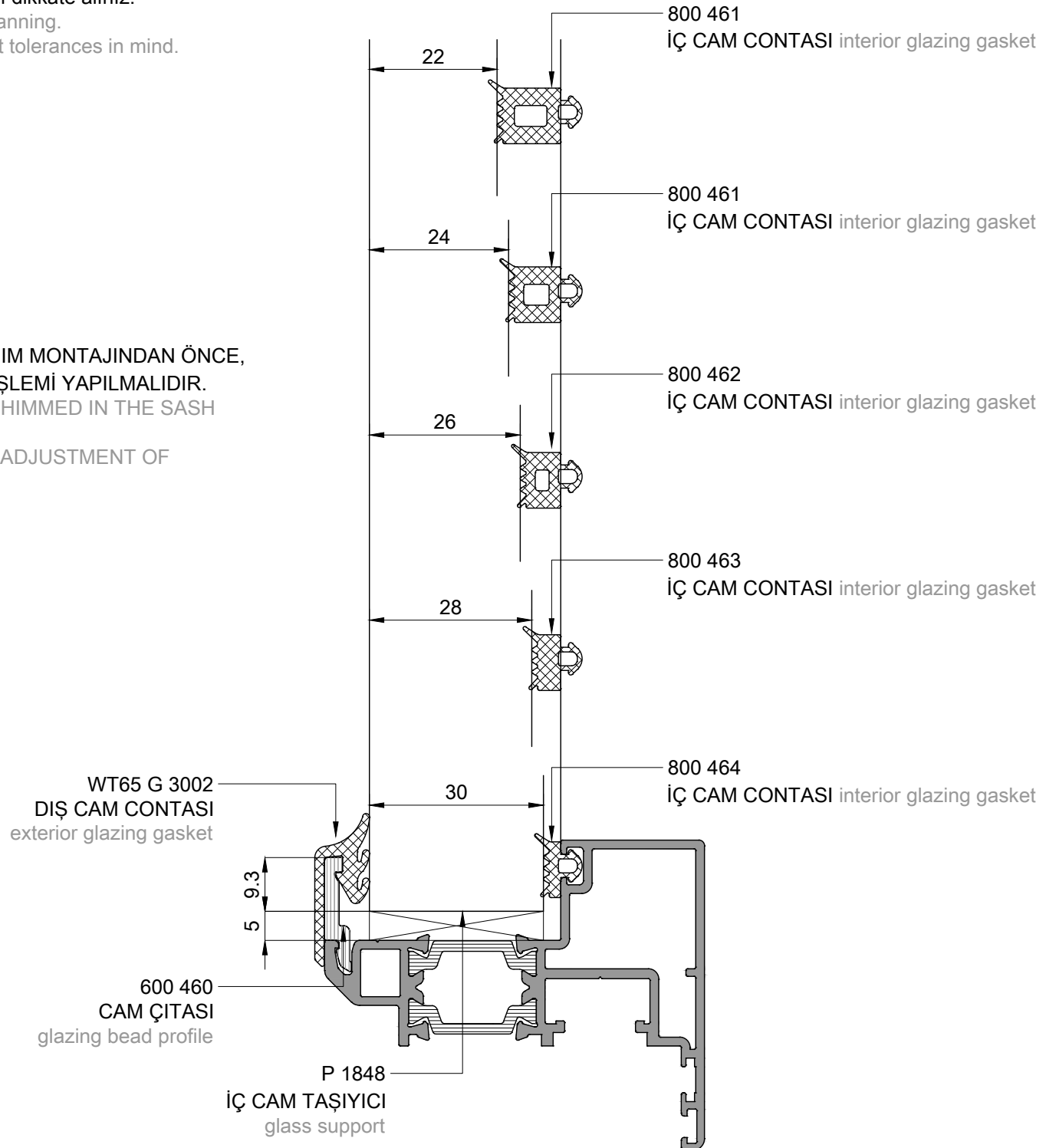

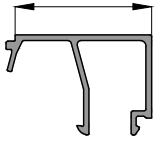

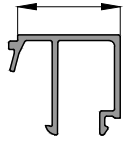

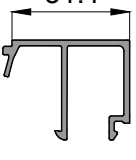



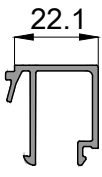
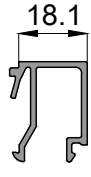



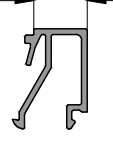

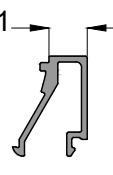
- ① **CAM TAKOZU**
Cam takozlari yerlesimi altta bulunan sematik çizimde gösterilmiştir. takozların kenara mesafeleri kanat ölçüsünün 5/1 i yada 10/1 i kadar olmalıdır.
GLASS CLEATS
The assembly of glass reinforcement pieces has been showed at the top schemetically. The gap distance to the corner should be, the 5/1 or 10/1 of the sash size.
- ② **MESAFE AYARLAMA TAKOZU**
Mesafe ayar takozlari camin alüminyum çerçeve içinde doğru pozisyonda stabil olarak durmasını sağlar. cam ile profil arasına takozlari zorlamadan yerleştiriniz.
DISTANCE ADJUSTMENT PIECE
Distance adjustment pieces stabilize the glass in the frame at the true position. Put the distance adjustment piece between glass and profile without using force.

Altta tablodaki veriler teoriktir.
Lütfen cam ve conta toleranslarını dikkate alınız.
selection tables promise a first planning.
Please keep the glass and gasket tolerances in mind.

AKSESUAR ve DONANIM MONTAJINDAN ÖNCE,
CAM ve TAKOZLAMA İŞLEMİ YAPILMALIDIR.
THE PANE MUST BE SHIMMED IN THE SASH
SO THAT THE SASH
OPERATES WITHOUT ADJUSTMENT OF
THE HARDWARE.



CAM KALINLIĞI glass thickness	CAM ÇITASI Glazing Bead	İÇ CAM CONTASI Interior Glazing Gasket	CAM KALINLIĞI glass thickness	CAM ÇITASI Glazing Bead	İÇ CAM CONTASI Interior Glazing Gasket
6mm	P 1498 (36mm) 36.1 	 800 271 (6mm)	14mm ----- 16mm	P 1180 (27mm) 27.1 	 800 277 (8mm) -----  800 271 (6mm)
8mm ----- 10mm ----- 12mm	P 1158 (31mm) 31.1 	 800 278 (10mm) -----  800 277 (8mm) -----  800 271 (6mm)	18mm ----- 20mm ----- 22mm ----- 24mm	P 1105 (22mm) 22.1  P 1179 (18mm) 18.1 	 800 277 (8mm) -----  800 271 (6mm) -----  800 277 (8mm) -----  800 271 (6mm)
			26mm ----- 28mm	P 1176 (14mm) 14.1 	 800 277 (8mm) -----  800 271 (6mm)
			30mm ----- 32mm	P 1494 (10mm) 10.1 	 800 277 (8mm) -----  800 271 (6mm)
			34mm ----- 36mm	P 1495 (6mm) 6.1 	 800 277 (8mm) -----  800 271 (6mm)
			38mm ----- 40mm	P 1496 (2mm) 2.1 	 800 277 (8mm) -----  800 271 (6mm)

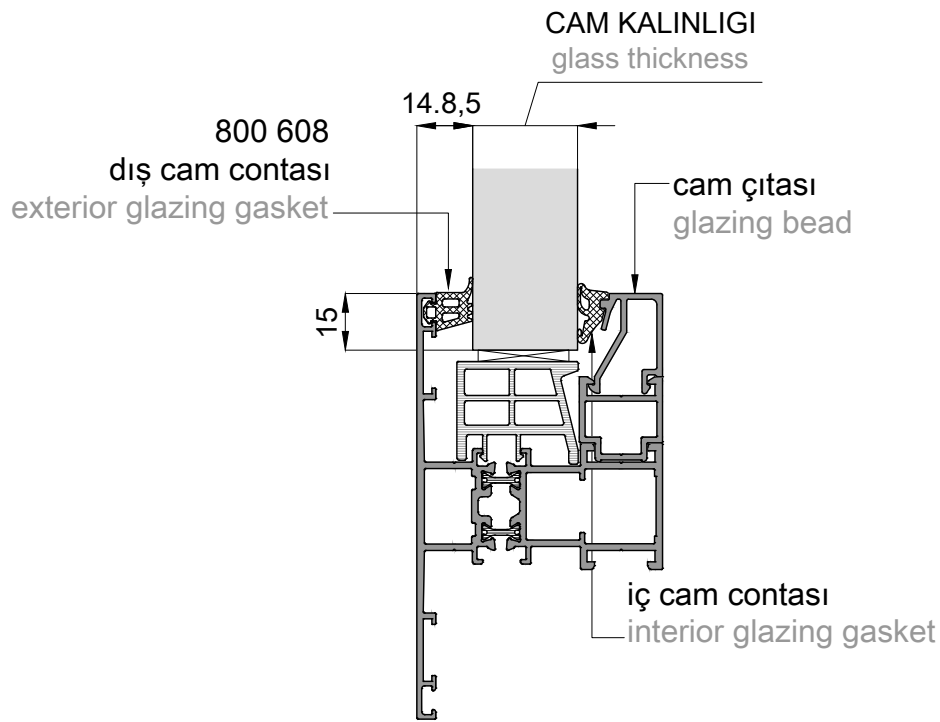







Yanda tablodaki veriler teoriktir.
Lütfen cam ve conta toleranslarını dikkate alınız.
selection tables promise a first planning.
Please keep the glass and gasket tolerances in mind.







WT65 FR
GİZLİ KANATLI KAPI ve PENCERE SİSTEMİ
HIDDEN SASH DOOR & WINDOW SYSTEM

ALUMİNYUM PROFİLLER
ALUMINIUM PROFILES

PROFİL ŞEKLİ PROFILE SECTION	PROFİL ADI PROFILE NO	KALIP KODU DIE NO	PROFİL TANIMI PROFILE DESCRIPTION	AĞIRLIK WEIGHT
	P 1795	12685 + 12686	L KASA PROFİLİ L Frame Profile	1,980kg/mt
	P 1796	12900 + 12901	L KASA PROFİLİ L Frame Profile	1,435kg/mt
	P 1797	16134 + 16135	T KASA PROFİLİ T Frame Profile	1,850kg/mt
	P 1869		L KASA PROFİLİ L Frame Profile	1,345kg/mt
	P 1865	12687 + 19165	DÜZ KANAT PROFİLİ Flat Sash Profile	1,245kg/mt
	P 1866	16138 + 19164	DÜZ YARIM KANAT PROFİLİ Half Flat Sash Profile	1,135kg/mt
	P 1798	12687 + 12688	OVAL KANAT PROFİLİ Ovoid Sash Profile	1,435kg/mt
	P 1799	12687 + 12768	OVAL KANAT PROFİLİ Ovoid Sash Profile	1,215kg/mt
	P 1800	16137 + 16138	OVAL YARIM KANAT PROFİLİ Half Ovoid Sash Profile	1,285kg/mt

PROFİL ŞEKLİ PROFILE SECTION	PROFİL ADI PROFILE NO	KALIP KODU DIE NO	PROFİL TANIMI PROFILE DESCRIPTION	AĞIRLIK WEIGHT
	P 1801	16136	ÇİFT KANAT KAPAK PROFİLİ Double Sash Cap Profile	0,555kg/mt
	P 1802	12848 + 12849	EŞİK PROFİLİ Threshold Profile	1,105kg/mt
	P 1803	16133	CAM CITA PROFİLİ Glazing Bead Profile	0,365kg/mt
	P 1804	12689 + 12690	ÇİFT KANAT ADAPTÖR PROFİLİ Double Sash Adapter Profile	1,800kg/mt
	P 1805	12709 + 12709	KASA EK PROFİLİ Elargisseur Profile	1,165kg/mt
	P 1806	12693	İÇ PERVAZ PROFİLİ Aile De Recouvrement profile	0,200kg/mt
	P 1807	12710	DIŞ PERVAZ PROFİLİ Tape Isolation profile	0,290kg/mt
	P 1808	12711	DIŞ PERVAZ PROFİLİ Tape Isolation profile	0,360kg/mt
	P 1809	12712	DIŞ PERVAZ PROFİLİ Tape Isolation profile	0,440kg/mt

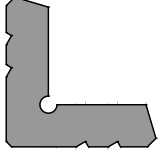
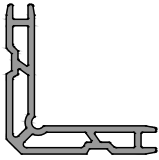
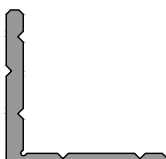
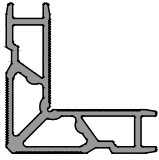
PROFİL ŞEKLİ PROFILE SECTION	PROFİL ADI PROFILE NO	KALIP KODU DIE NO	PROFİL TANIMI PROFILE DESCRIPTION	AĞIRLIK WEIGHT
	P 1810	15979	DIŞ PERVAZ PROFİLİ Tape Isolation profile	0,515kg/mt
	P 1811	12713	DIŞ PERVAZ PROFİLİ Tape Isolation profile	0,590kg/mt
	P 1812	12694	DENİZLİK PROFİLİ Piece D'appui Profile	0,895kg/mt
	P 1813	12714	CAM ÇITA PROFİLİ Glazing Bead Profile	0,365kg/mt
	P 1176	13698	14mm CAM ÇITASI 14mm glazing bead profile	0,335kg/mt
	P 1179	13671	18mm CAM ÇITASI 18mm glazing bead profile	0,350kg/mt
	P 1180	13670	27mm CAM ÇITASI 27mm glazing bead profile	0,380kg/mt
	P 1105	13113	22mm CAM ÇITASI 22mm glazing bead profile	0,360kg/mt
	P 1158	13111	31mm CAM ÇITASI 31mm glazing bead profile	0,365kg/mt
	P 1494	15306	10mm CAM ÇITASI 10mm glazing bead profile	0,325kg/mt

PROFİL ŞEKLİ PROFILE SECTION	PROFİL ADI PROFILE NO	KALIP KODU DIE NO	PROFİL TANIMI PROFILE DESCRIPTION	AĞIRLIK WEIGHT
	P 1495	15307	6mm CAM ÇITASI 6mm glazing bead profile	0,270kg/mt
	P 1496	15308	2mm CAM ÇITASI 2mm glazing bead profile	0,245kg/mt
	P 1498	15310	36mm CAM ÇITASI 36mm glazing bead profile	0,415kg/mt
	P 1013	12715	CAM TAŞIYICI PROFİLİ Glass Support Profile	0,260kg/mt
	P 1015	338	KÖŞE TAKOZ PROFİLİ Corner Cleat Profile	5,990kg/mt
	P 1701	9084	KÖŞE TAKOZ PROFİLİ Corner Cleat Profile	2,360kg/mt
	P 1814	6209	KÖŞE TAKOZ PROFİLİ Corner Cleat Profile	2,905kg/mt
	P 2361	9133	KÖŞE TAKOZ PROFİLİ Corner Cleat Profile	2,710kg/mt
	P 1815	16097	100x60x1,8 KÖŞEBENT PROFİLİ 100x60x1,8 Angle Profile	0,775kg/mt









WT65 FR
GİZLİ KANATLI KAPI ve PENCERE SİSTEMİ
HIDDEN SASH DOOR & WINDOW SYSTEM







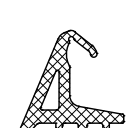
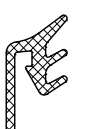

PVC PROFİLLER
PVC PROFILES

PROFİL ŞEKLİ PROFILE SECTION	PROFİL ADI PROFILE NO	MALZEME MATERIAL	PROFİL TANIMI PROFILE DESCRIPTION	PAKET PACKAGE
	600 460	POLYAMİD polyamide	CAM ÇITA PROFİLİ Glazing Bead Profile	6mt 25ad/pk
	600 461	PVC	KAPI ALT EKLEME PROFİLİ Additional Profile for Door Bottom	6mt 25ad/pk
	600 462	PVC	CAM TAŞIYICI PROFİL Glass Support Profile	6mt 25ad/pk

WT65 FR
GİZLİ KANATLI KAPI ve PENCERE SİSTEMİ
HIDDEN SASH DOOR & WINDOW SYSTEM



CONTALAR
GASKETS

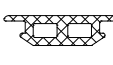

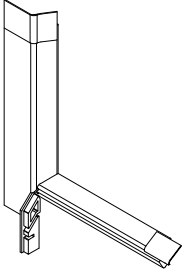
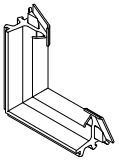
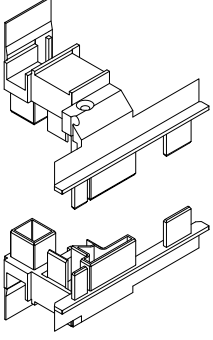
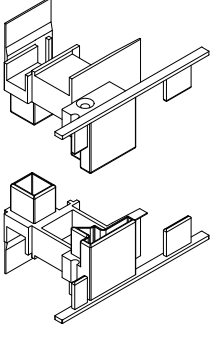

CONTA ŞEKLİ GASKET SECTION	CONTA KODU GASKET NO	MALZEME MATERIAL	CONTA TANIMI GASKET DESCRIPTION	PAKET PACKAGE
	800 234	EPDM	Ø4 DAİRESEL CONTASI Ø4 oring gasket	820mt/pk 0,016kg/mt
	800 460	EPDM	11mm İÇ CAM CONTASI 11mm interior glazing gasket	127mt/pk 0,118kg/mt
	800 461	EPDM	9mm İÇ CAM CONTASI 9mm interior glazing gasket	153mt/pk 0,098kg/mt
	800 462	EPDM	7mm İÇ CAM CONTASI 7mm interior glazing gasket	180mt/pk 0,083kg/mt
	800 463	EPDM	5mm İÇ CAM CONTASI 5mm interior glazing gasket	220mt/pk 0,068kg/mt
	800 464	EPDM	3mm İÇ CAM CONTASI 3mm interior glazing gasket	340mt/pk 0,044kg/mt
	800 500	EPDM	ORTA SIZDIRMAZLIK CONTASI central tightness gasket	84mt/pk 0,178kg/mt
	800 501	EPDM	DIŞ CAM CONTASI exterior glazing gasket	130mt/pk 0,115kg/mt
	800 502	EPDM	4mm İÇ CAM CONTASI 4mm interior glazing gasket	190mt/pk 0,078kg/mt
	800 503	EPDM	İÇ BİNİ CONTASI interior overlap gasket	430mt/pk 0,035kg/mt

CONTA ŞEKLİ GASKET SECTION	CONTA KODU GASKET NO	MALZEME MATERIAL	CONTA TANIMI GASKET DESCRIPTION	PAKET PACKAGE
	800 504	EPDM	KAPI ALT CONTASI door bottom gasket	625mt/pk 0,024kg/mt
	800 505	EPDM	DIŞ BİNİ CONTASI exterior overlap gasket	625mt/pk 0,024kg/mt
	800 506	EPDM	KAPI ALT BİNİ CONTASI door bottom overlap gasket	470mt/pk 0,032kg/mt
	800 608	EPDM	DIŞ CAM CONTASI exterior glazing gasket	144mt/pk 0,104kg/mt
	800 228	EPDM	4mm İÇ CAM CONTASI 4mm interior glazing gasket	185mt/pk 0,081kg/mt
	800 271	EPDM	6mm İÇ CAM CONTASI interior glazing gasket	185mt/pk 0,081kg/mt
	800 277	EPDM	8mm İÇ CAM CONTASI 8mm interior glazing gasket	165mt/pk 0,092kg/mt
	800 278	EPDM	10mm İÇ CAM CONTASI 10mm interior glazing gasket	115mt/pk 0,130kg/mt
	800 298	EPDM	EŞİK PROFİLİ KANAL KAPATMA CONTASI closing gasket for threshold	185mt/pk 0,082kg/mt

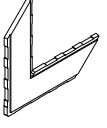
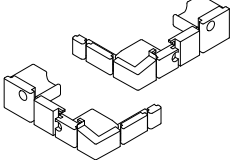
WT65 FR
GİZLİ KANATLI KAPI ve PENCERE SİSTEMİ
HIDDEN SASH DOOR & WINDOW SYSTEM

AKSESUARLAR
ACCESSORIES

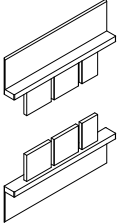
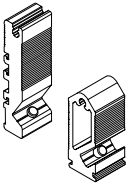
AKSESUAR ŐEKLİ ACCESSORIES SHAPE	AKSESUAR ACCESS. NO	AKSESUAR TANIMI ACCESSORIES DESCRIPTION	MİKTAR QUANTITY
	700 806	DIŐ CAM CONTASI VULKANİZE KÖŐE CONTA vulanized corner piece for exterior glazing gasket	25 çift/pair
	700 844	ORTA SIZDIRMAZLIK CONTASI İÇİN KÖŐE VULKANİZE vulcanized corner for central gasket	50 adet/pieces
	700 807	ÇİFT KANAT PENCERE ADAPTÖR KAPAGI double sash window adepter cap plug	25 çift/pair
	700 808	ÇİFT KANAT KAPI ADAPTÖR KAPAGI double sash door adepter cap plug	25 çift/pair
	700 329	ALUMİNYUM KÖŐE ONBAŐI aluminum corner angle	500 adet/pieces
	700 303	PVC KÖŐE ONBAŐI pvc corner angle	500 adet/pieces
	700 809	KAPI EŐİK KAPAGI cap plug for door threshold	25 çift/pair

AKSESUAR ŞEKLİ ACCESSORIES SHAPE	AKSESUAR ACCESS. NO	AKSESUAR TANIMI ACCESSORIES DESCRIPTION	MİKTAR QUANTITY
	700 720	ORTA SIZDIRMAZLIK VULKANİZE CONTA vulanized corner piece for central tightness gasket	25 çift/pair
	700 721	YARIM KANAT PENCERE ADAPTÖR KAPAGI half sash window adapter cap plug	25 çift/pair
	700 722	ÇİFT KANAT KAPI DIŞ ADAPTÖR KAPAGI double sash door exterior adapter cap plug	25 çift/pair
	700 723	ORTA KAYIT BİRLEŞİM ANKRAJI T connection bracket for mullion	25 çift/pair
	700 810	ORTAKAYIT BİRLEŞİM için EPDM KÖPÜK epdm foam for T connection	100 adet/pieces
	700 336	SU TAHLİYE KAPAGI water drain cap	100 adet/pieces

WT65 FR
GİZLİ KANATLI KAPI ve PENCERE SİSTEMİ
HIDDEN SASH DOOR & WINDOW SYSTEM

TAM ÖLÇEKLİ ALUMİNYUM PROFİLLER
FULL SCALE PROFILES

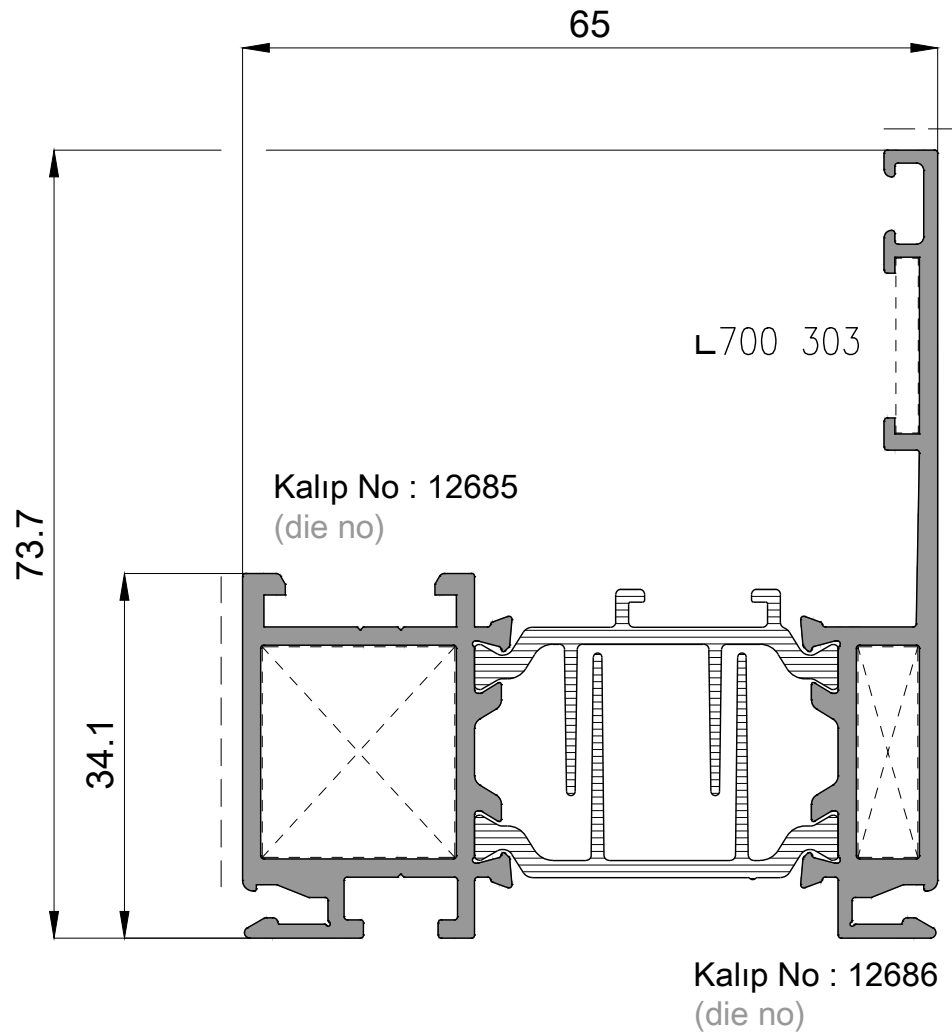

P 1795

L Kasa Profil / L Frame Profile
1,980kg/mt

I_x)
26.17 cm⁴

I_y)
12.05 cm⁴

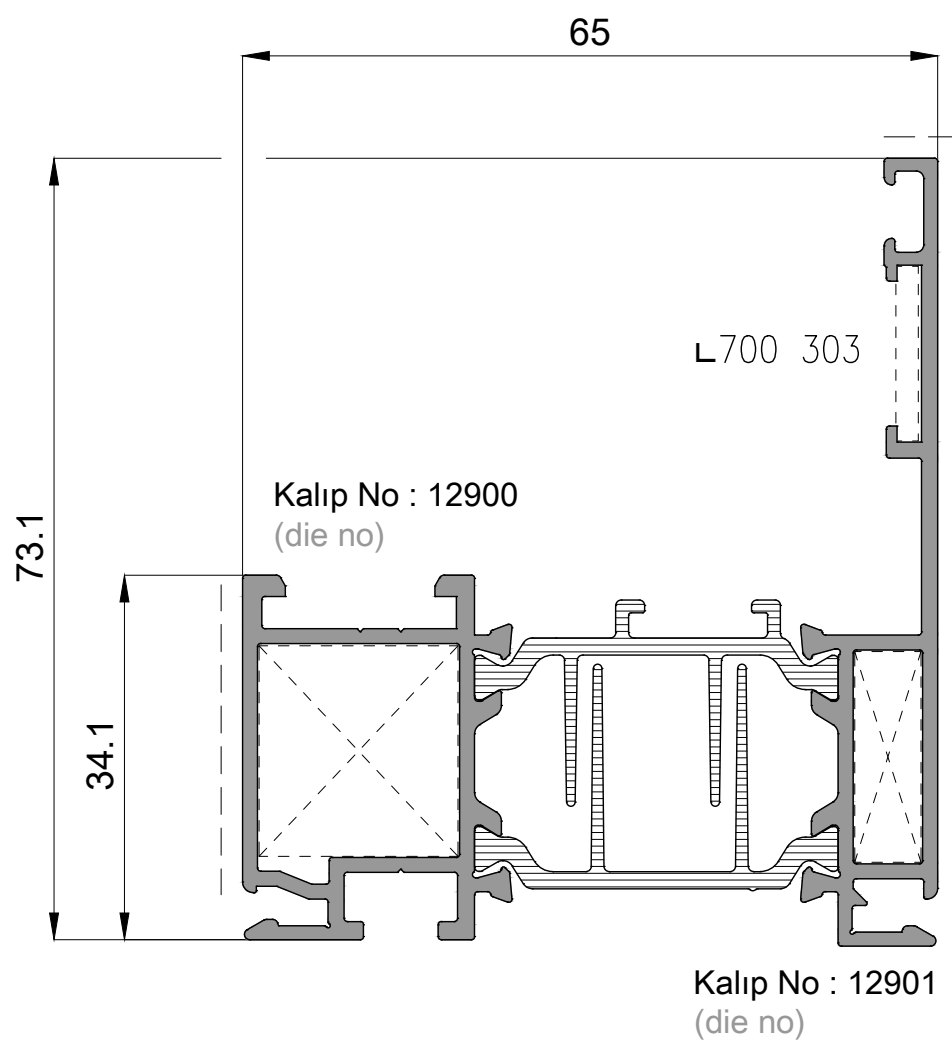

P 1796



L Kasa Profil / L Frame Profile
1,435kg/mt

I_x)
22.80 cm⁴

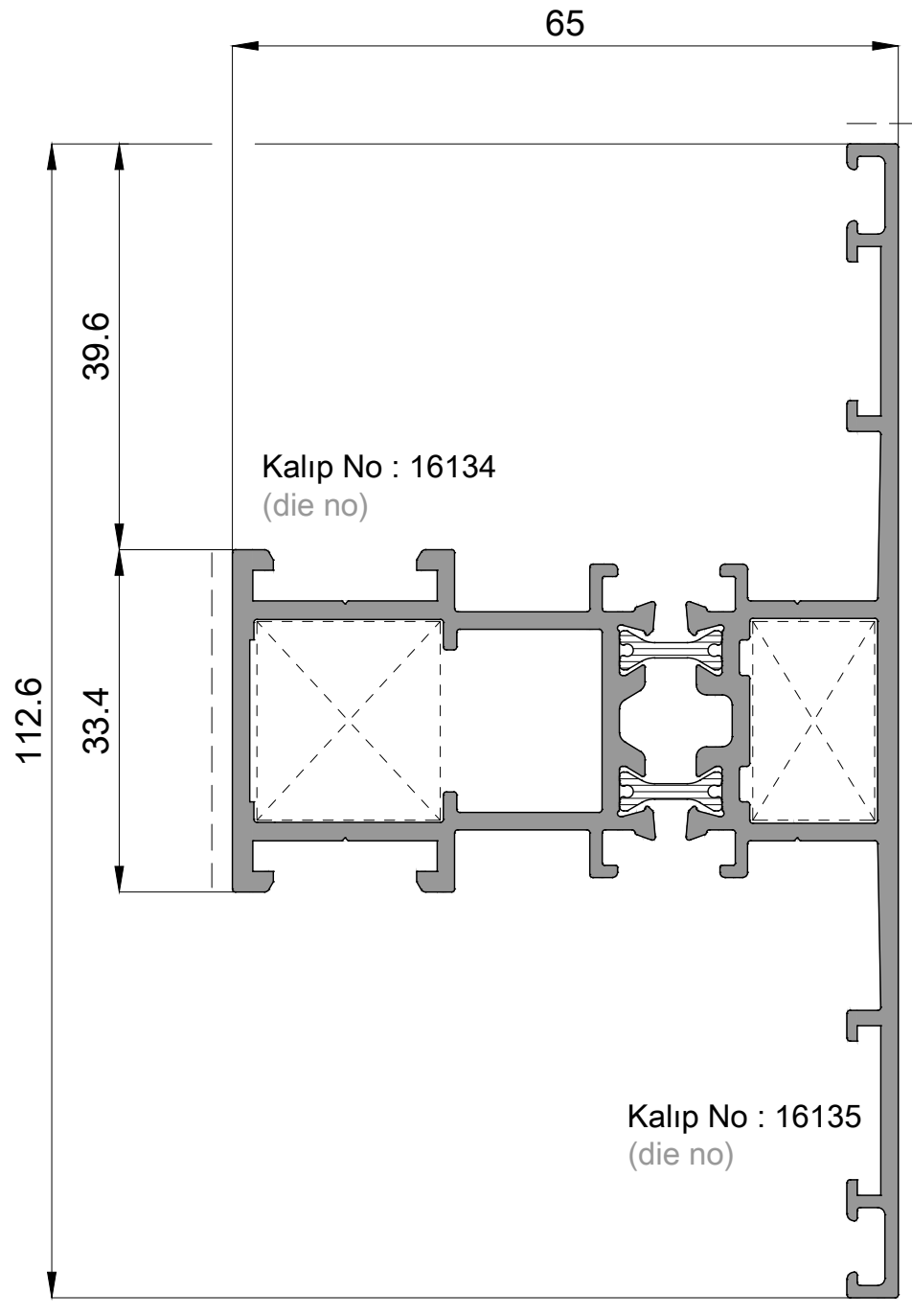
I_y)
10.75 cm⁴



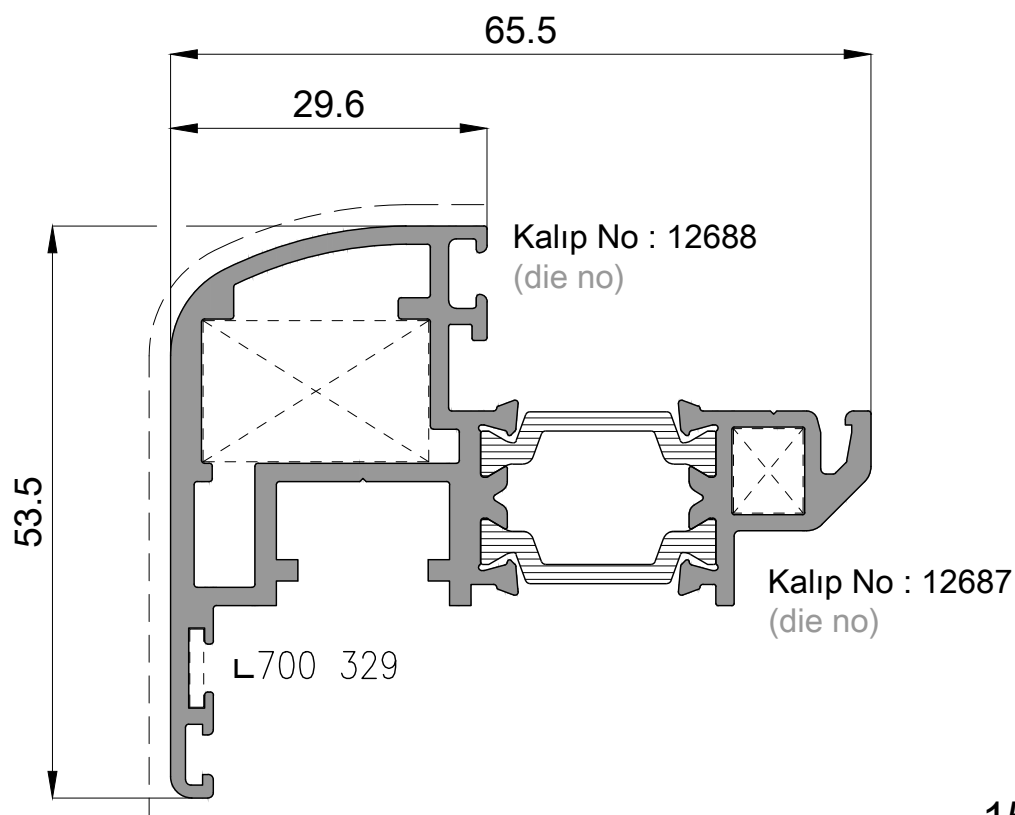

P 1797
T Kasa Profili / T Frame Profile
1,850kg/mt

I_x  24.91 cm⁴ I_y  30.43 cm⁴



P 1798
Kanat Profili / Sash Profile
1,435kg/mt

I_x  15.03 cm⁴ I_y  6.45 cm⁴

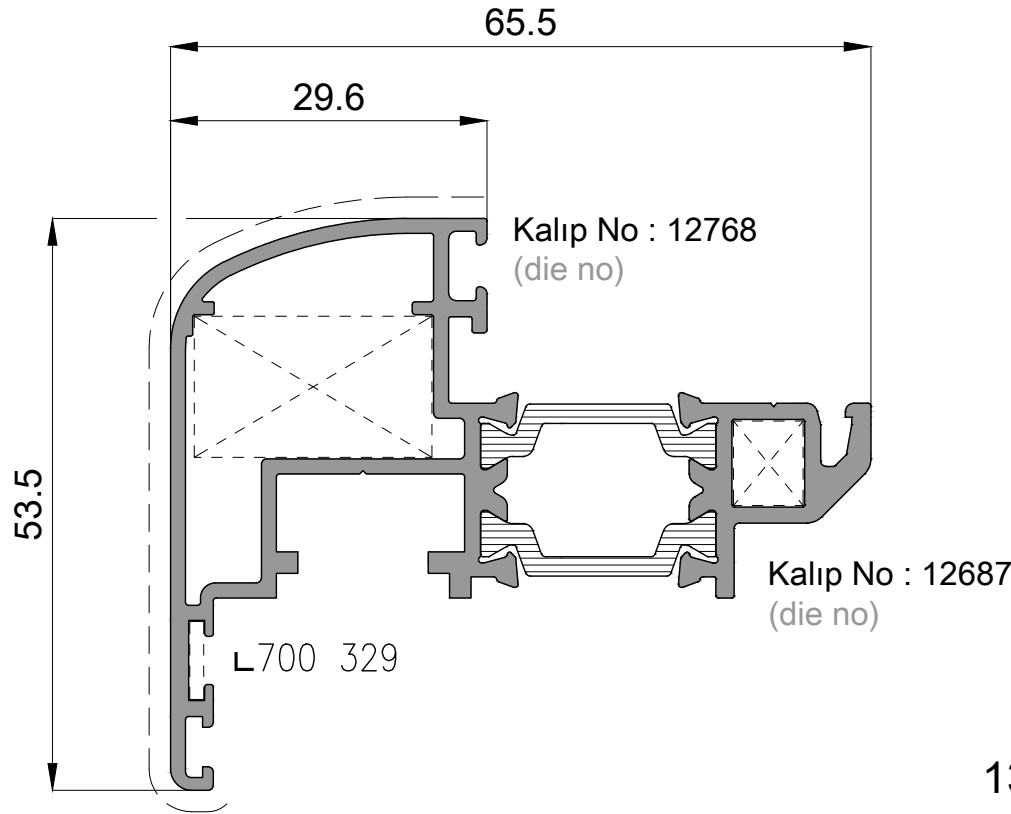

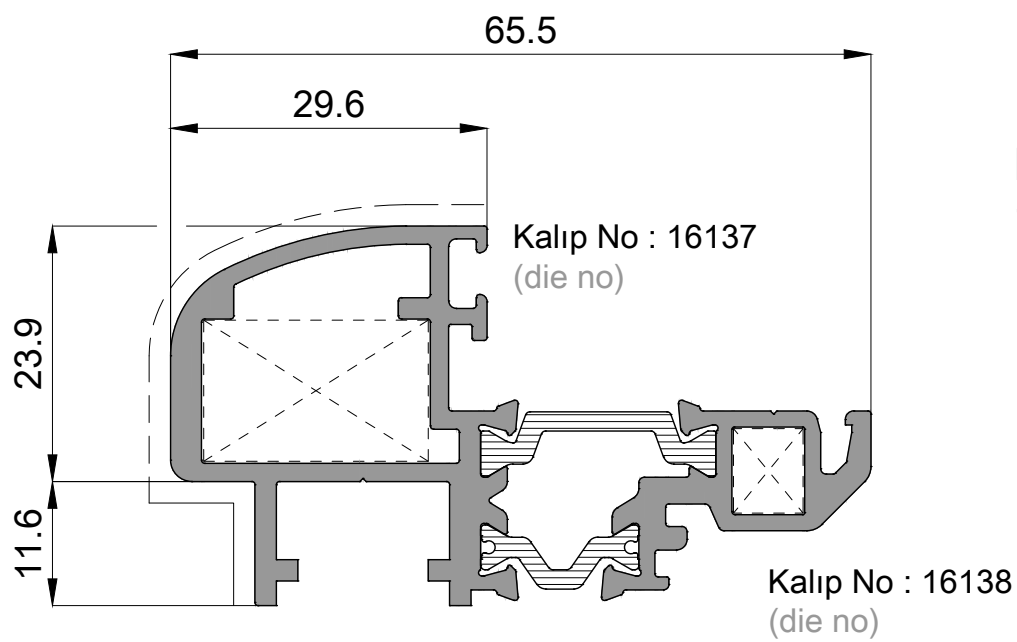

P 1799
Kanat Profili / Sash Profile
1,215kg/mt

I_x  13.18 cm⁴
 I_y  5.54 cm⁴



P 1800
Kanat Profili / Sash Profile
1,285kg/mt

I_x  12.21 cm⁴
 I_y  3.32 cm⁴

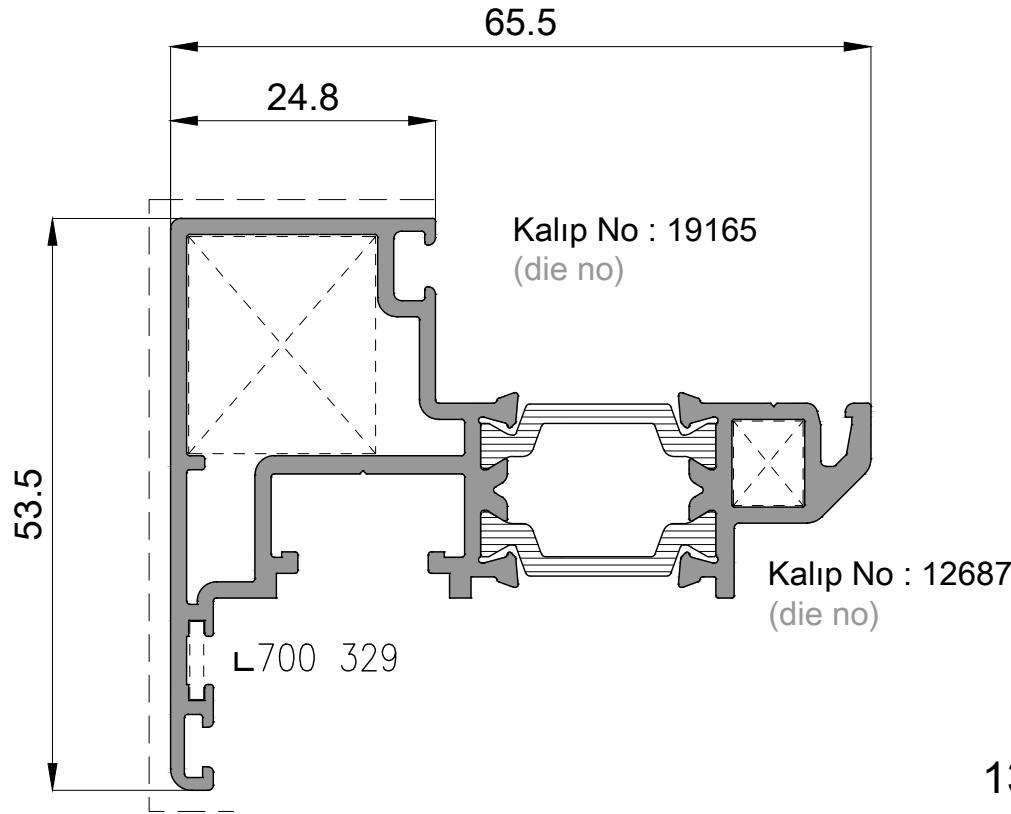

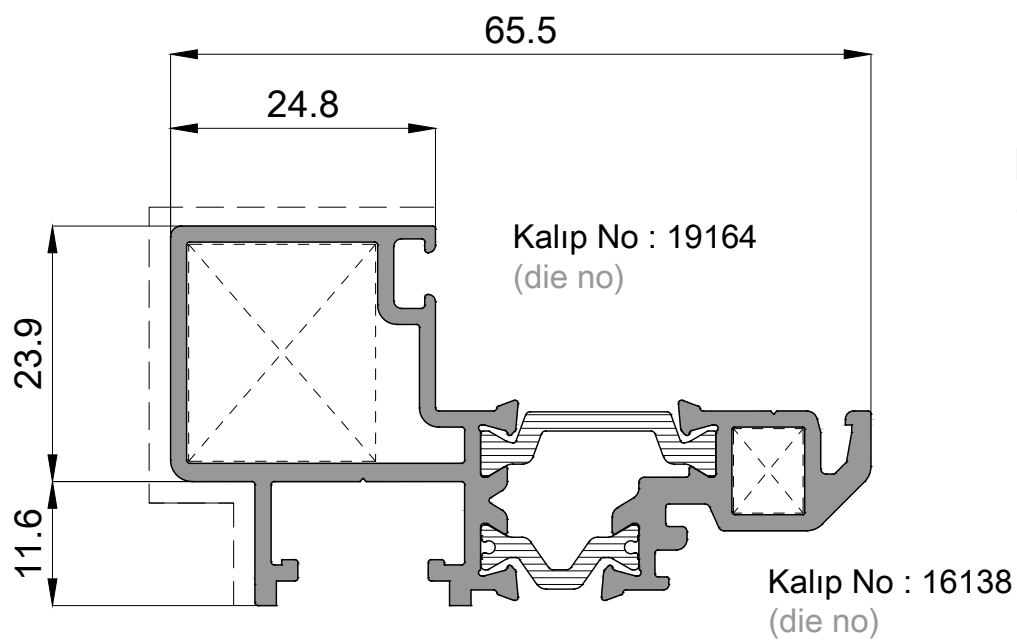

P 1865
Kanat Profili / Sash Profile
1,245kg/mt

I_x  13.84 cm⁴
 I_y  5.82 cm⁴



P 1866
Kanat Profili / Sash Profile
1,135kg/mt

I_x  11.42 cm⁴
 I_y  2.85 cm⁴

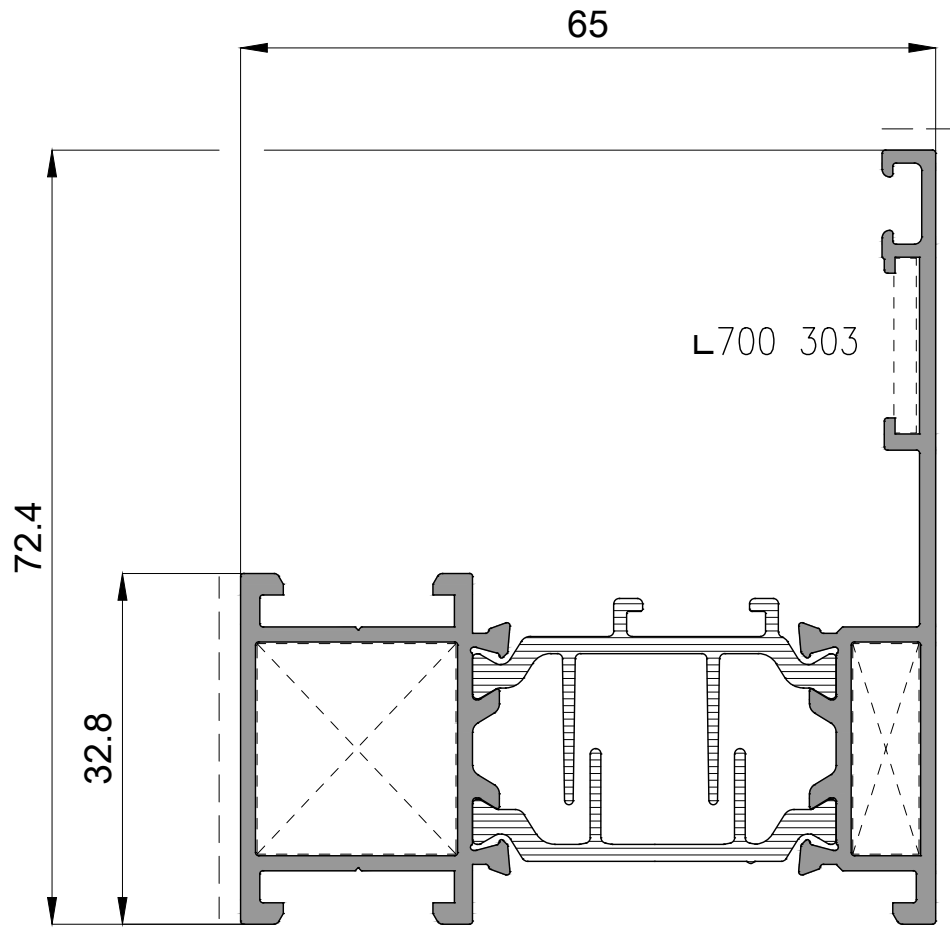

P 1869

L Kasa Profili / L Frame Profile
1,345kg/mt

I_x)
21.61 cm⁴

I_y)
9.69 cm⁴

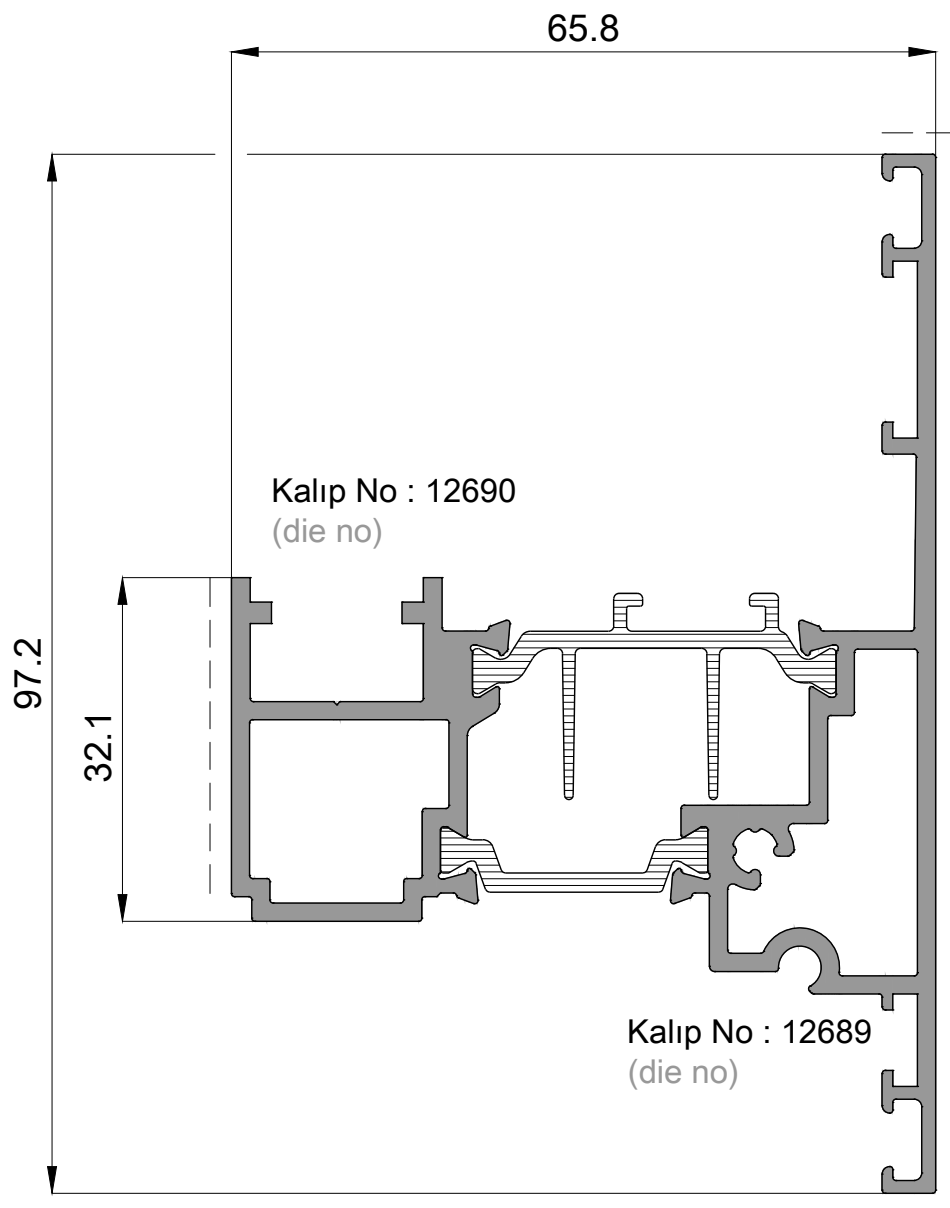

P 1804

ÇİFT KANAT ADAPTÖR PROFİLİ
Double Sash Adepter Profile
1,800kg/mt

I_x)
25.17 cm⁴

I_y)
22.04 cm⁴

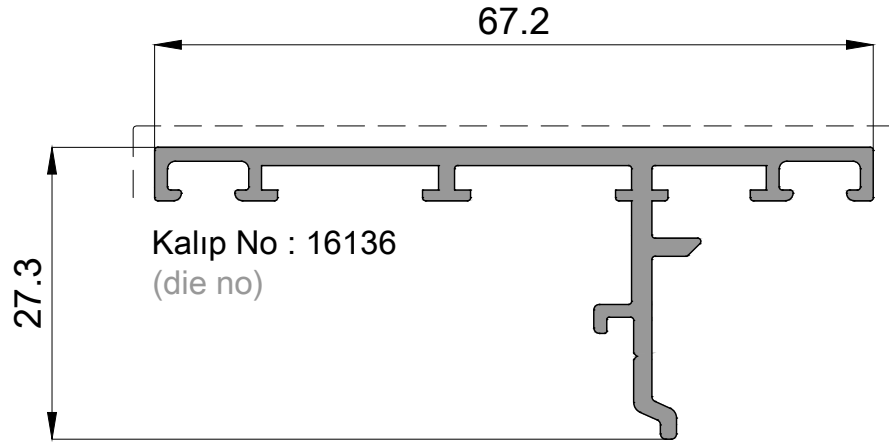

P 1801

L Kasa Profili / L Frame Profile
0,555kg/mt

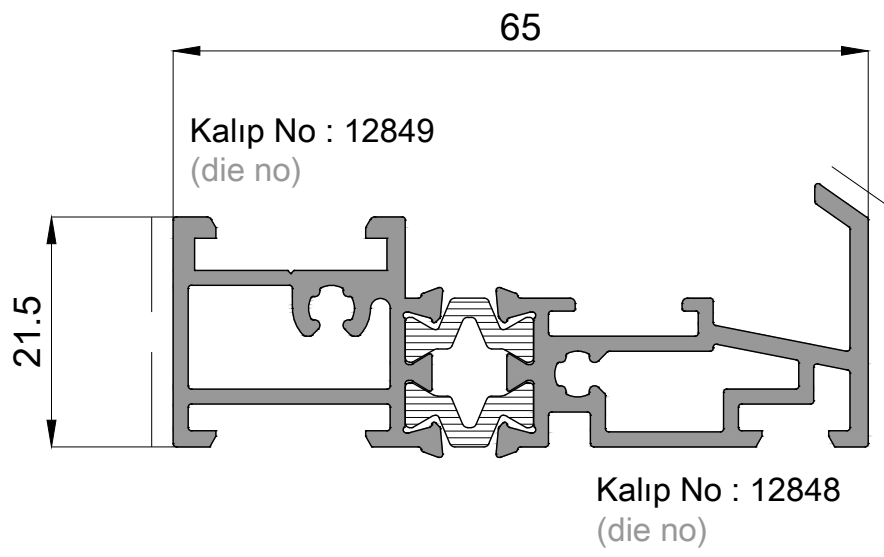

P 1802

Eşik Profili / Threshold Profile
1,105kg/mt

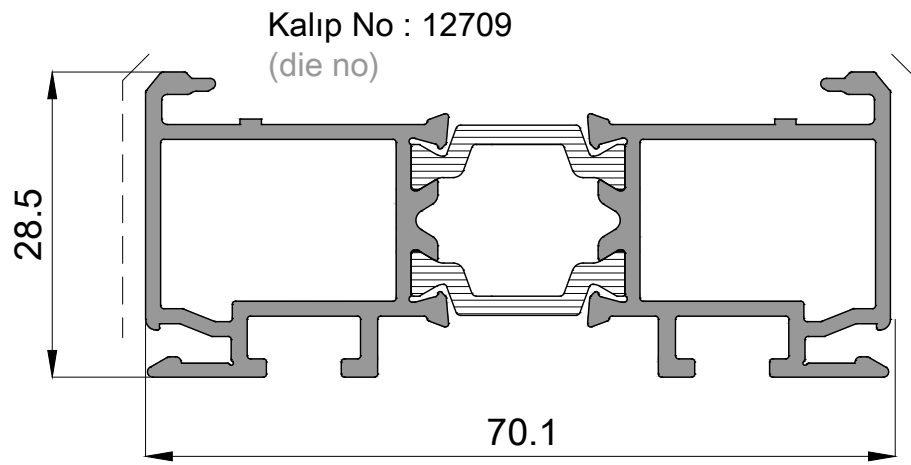

P 1805

Kasa Ek Profili / Elargisseur Profile
1,165kg/mt

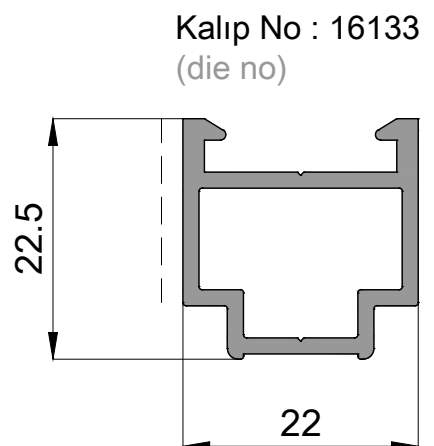

P 1803

Cam Çıta Profili / Glazing Bead Profile
0,365kg/mt

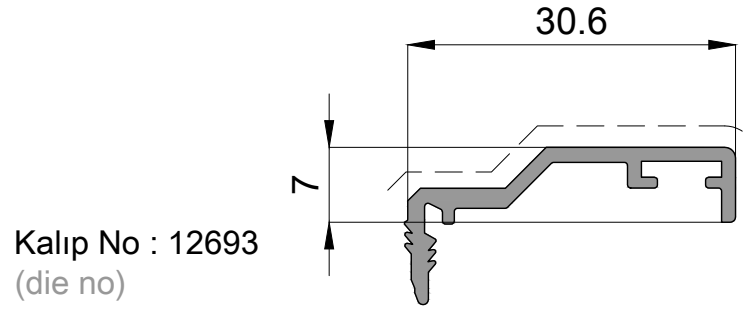

P 1806

İç Pervaz Profili

Aile De Recouvrement Profile

0,200kg/mt

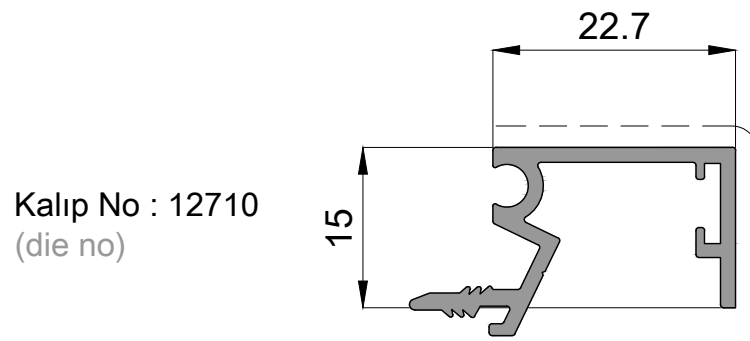

P 1807

Dış Pervaz Profili

Tape Isolation Profile

0,290kg/mt

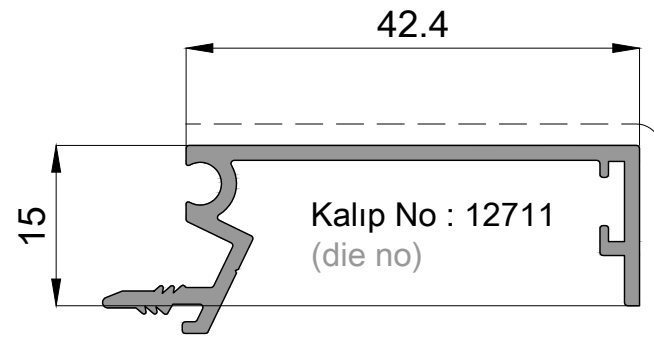

P 1808

Dış Pervaz Profili

Tape Isolation Profile

0,360kg/mt

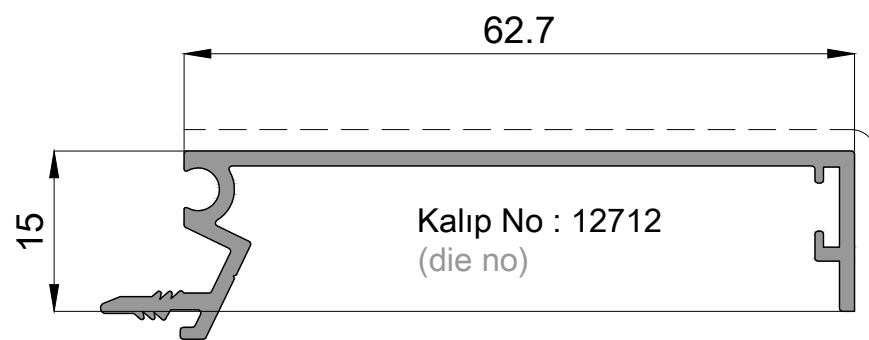

P 1809

Dış Pervaz Profili

Tape Isolation Profile

0,440kg/mt

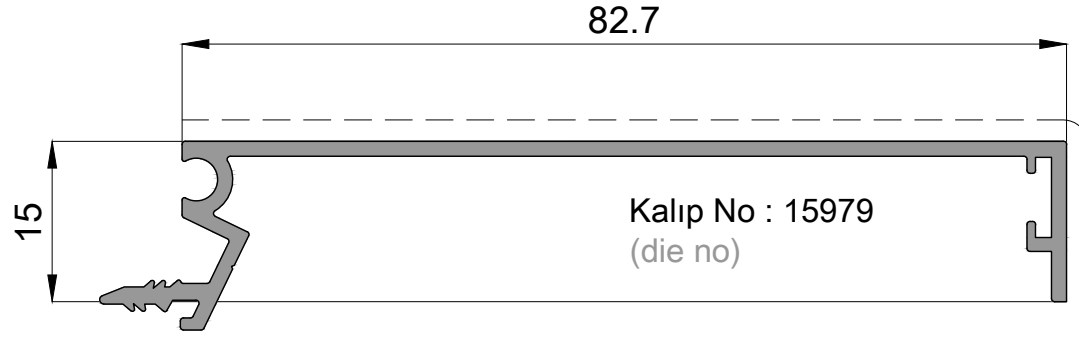

P 1810
Dış Pervaz Profili
Tape Isolation Profile
0,515kg/mt

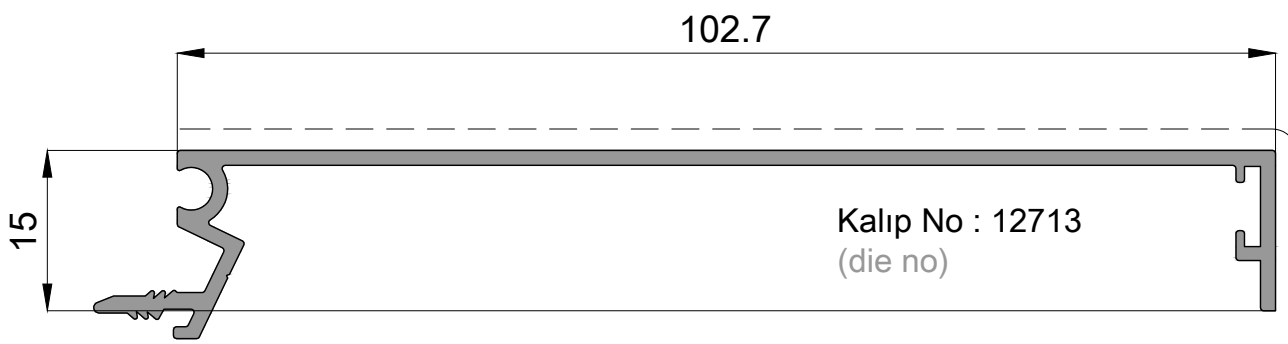

P 1811
Dış Pervaz Profili
Tape Isolation Profile
0,590kg/mt

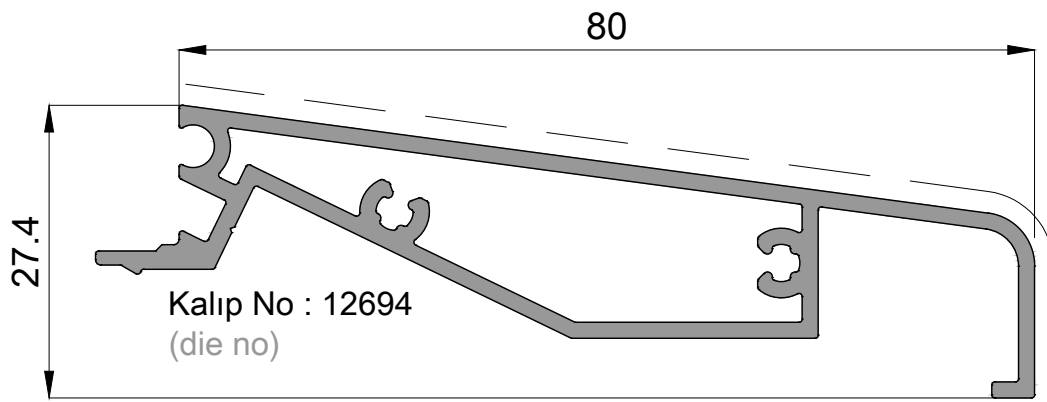

P 1812
Denizlik Profili
Piece D'appui Profile
0,895kg/mt

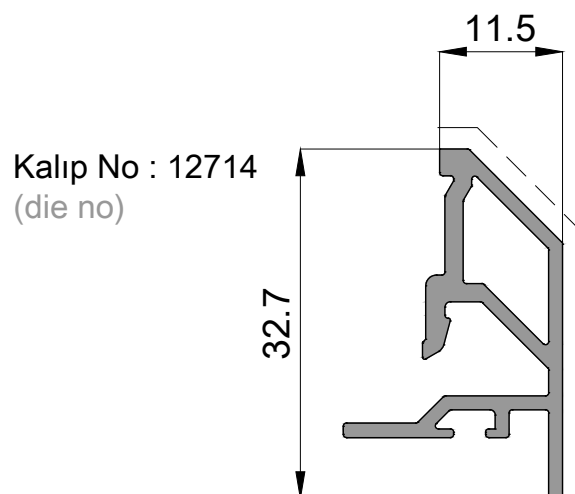

P 1813
Cam Çita Profili
Glazing Bead Profile
0,365kg/mt

P 1176

Çıta Profili / glazing bead profile
0,335kg/mt

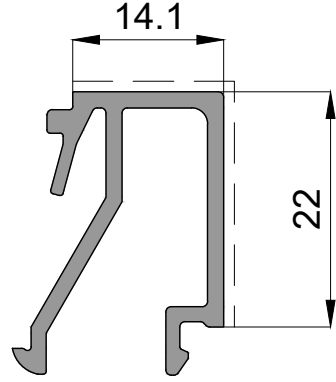

Kalıp / die no : 13698

P 1179

Çıta Profili / glazing bead profile
0,350kg/mt

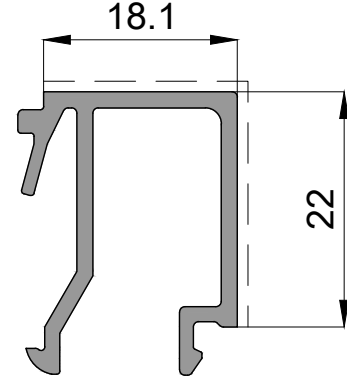

Kalıp / die no : 13671

P 1180

Çıta Profili / glazing bead profile
0,380kg/mt

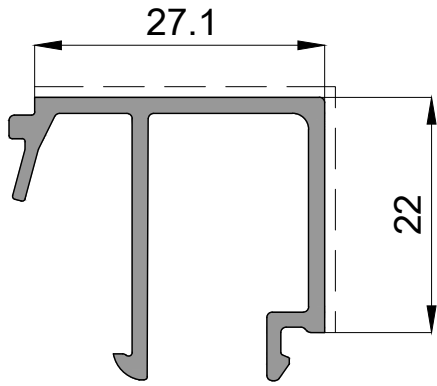

Kalıp / die no : 13670

P 1105

Çıta Profili / glazing bead profile
0,360kg/mt

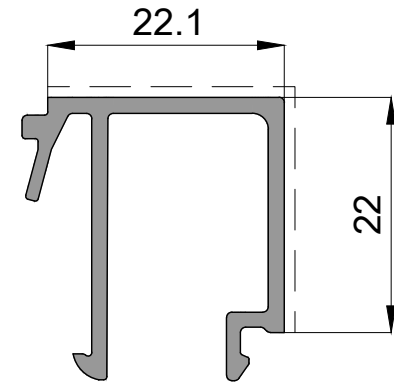

Kalıp / die no : 13113

P 1158

Çıta Profili / glazing bead profile
0,365kg/mt

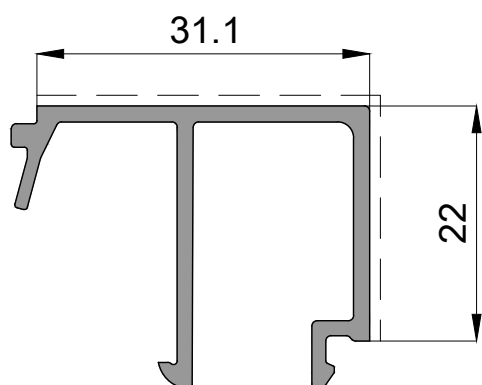

Kalıp / die no : 13111

P 1498

Çıta Profili / glazing bead profile
0,415kg/mt

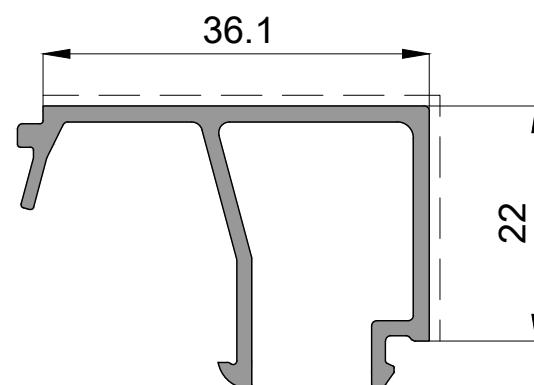

Kalıp / die no : 15310

P 1494

Çıta Profili / 0,325kg/mt
Glazing Bead Profile

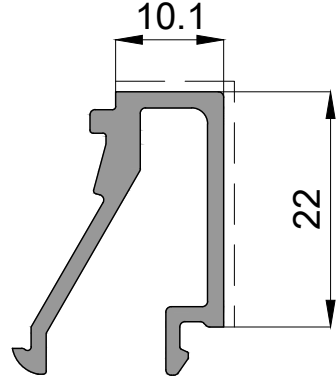

Kalıp : 15306
(die no)

P 1495

Çıta Profili / 0,270kg/mt
Glazing Bead Profile

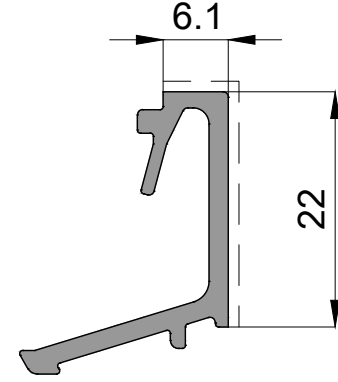

Kalıp : 15307
(die no)

P 1496

Çıta Profili / 0,245kg/mt
Glazing Bead Profile

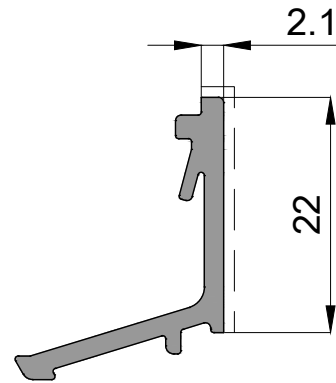

Kalıp : 15308
(die no)

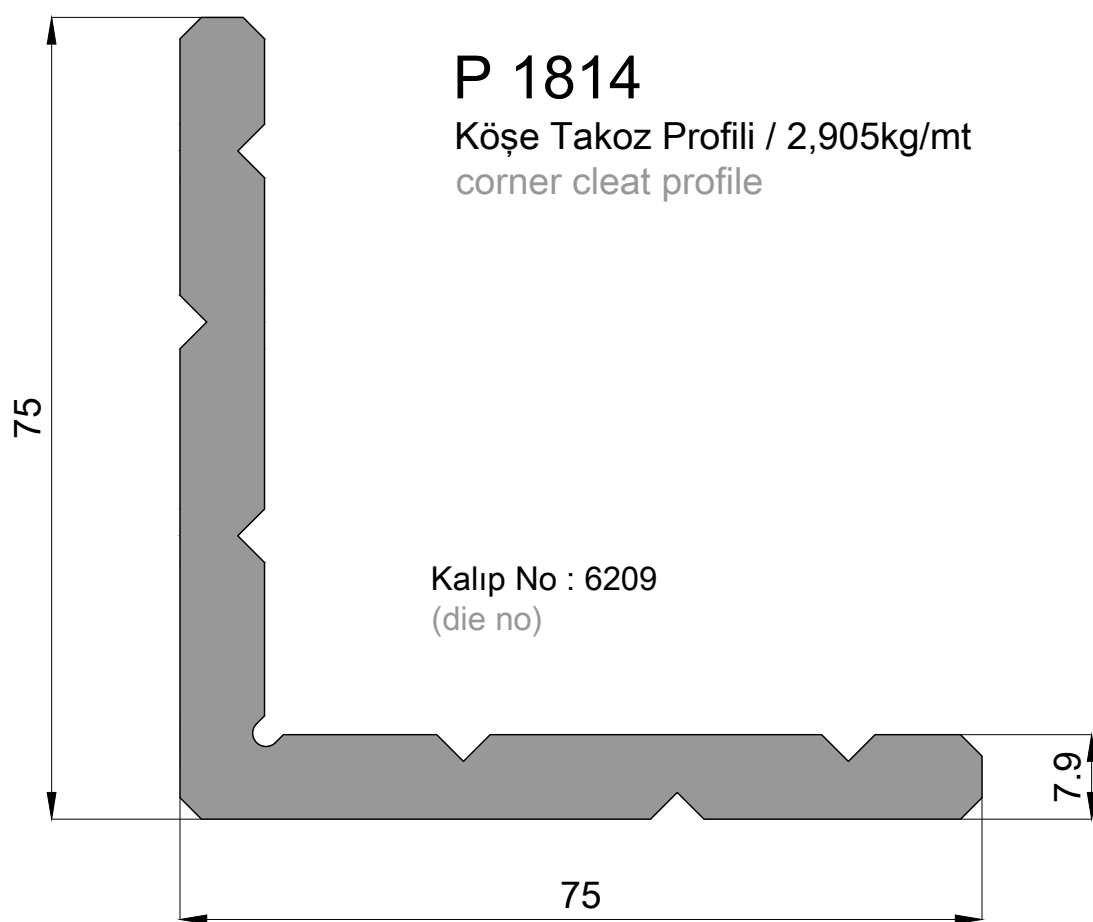
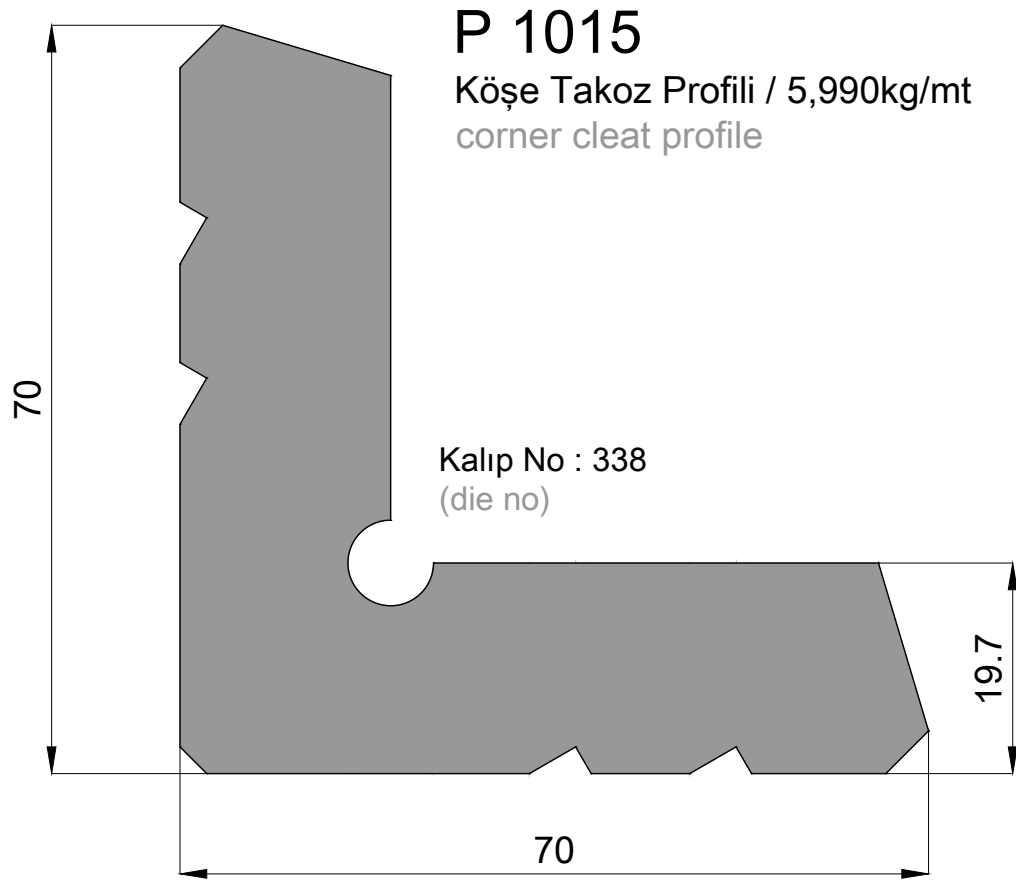

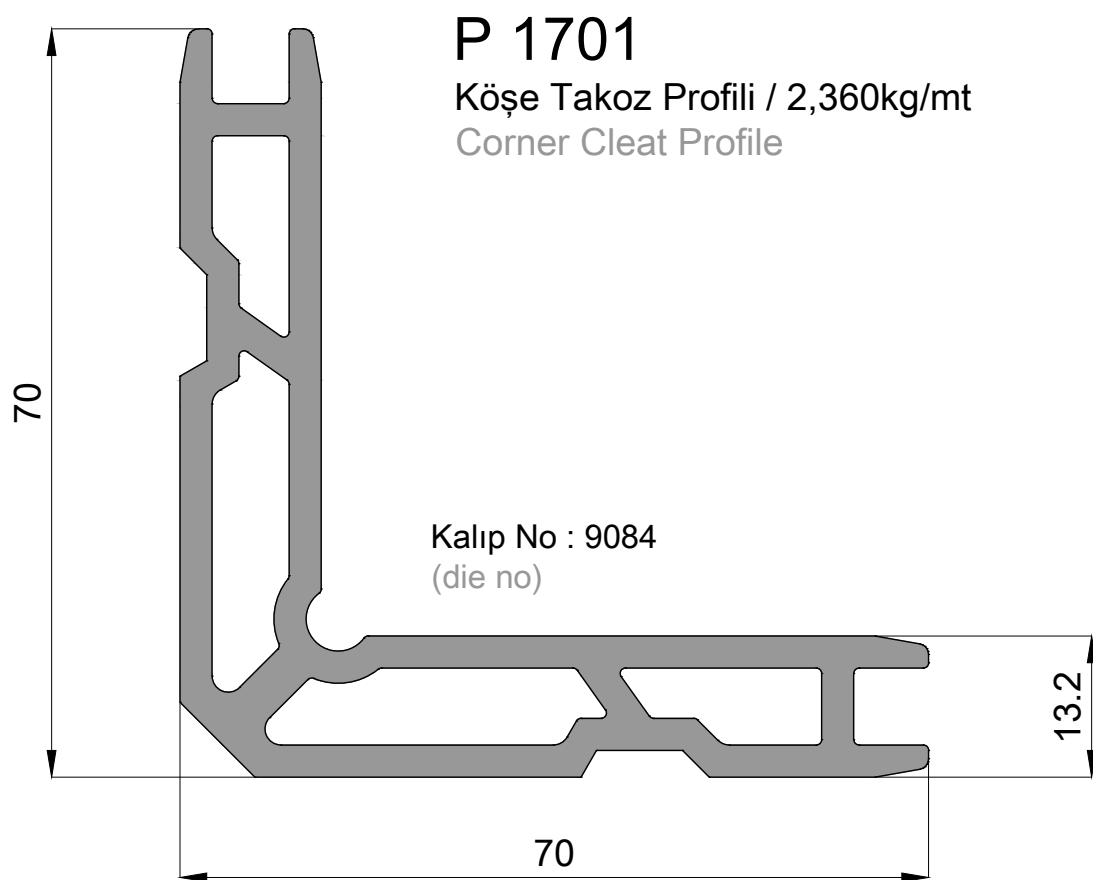
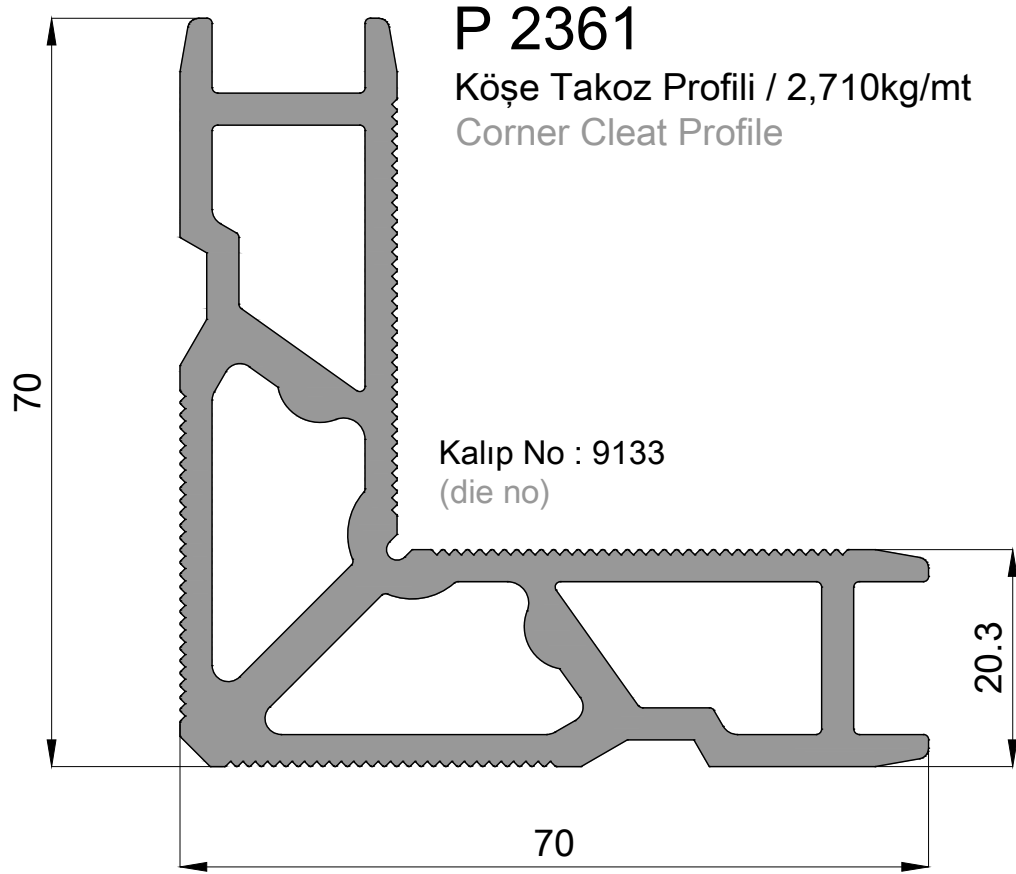

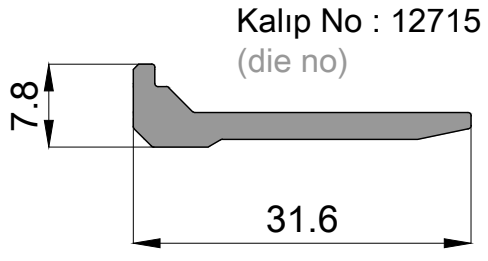

P 1013

CAM TAŞIYICI PROFİL / 0,260kg/mt
Glass Support Profile

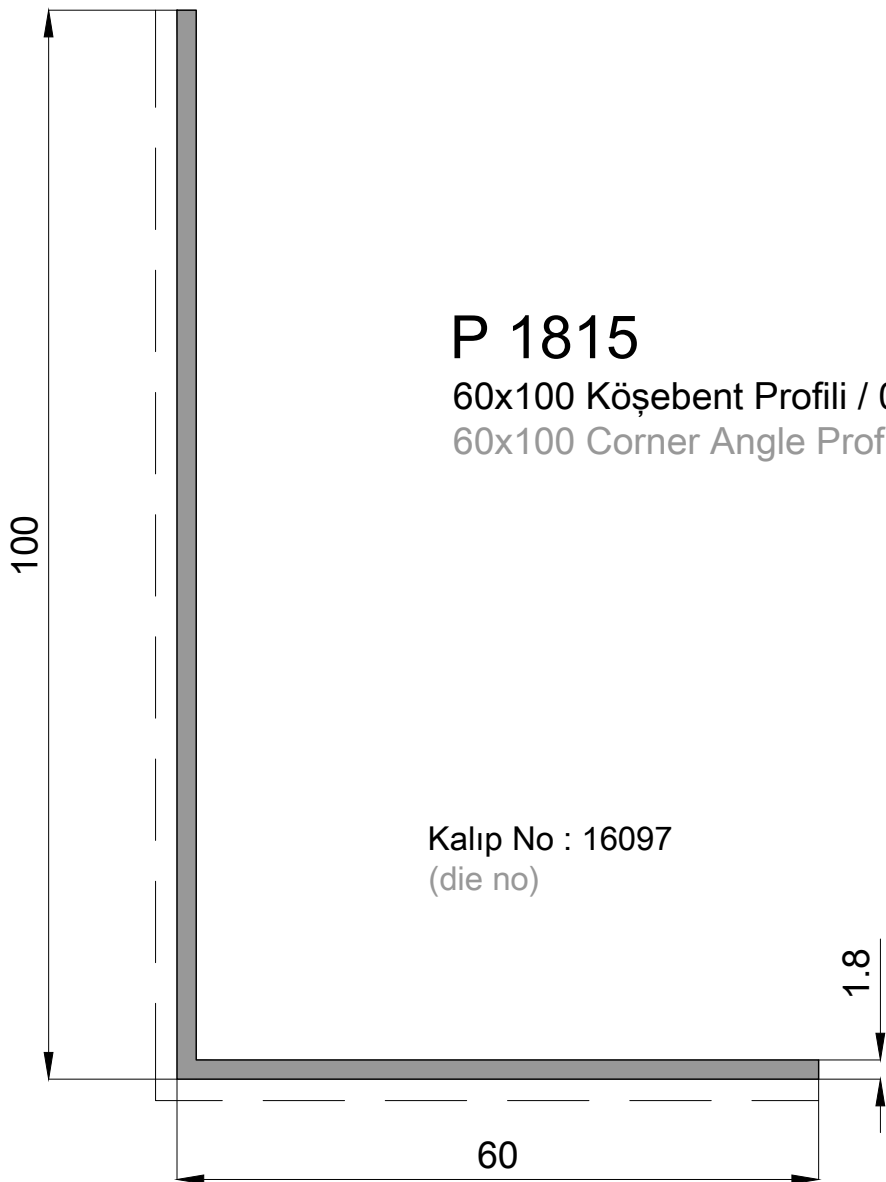

P 1815

60x100 Köşebent Profili / 0,775kg/mt
60x100 Corner Angle Profile

Kalıp No : 16097
(die no)

WT65 FR
GİZLİ KANATLI KAPI ve PENCERE SİSTEMİ
HIDDEN SASH DOOR & WINDOW SYSTEM

PRENSİP SİSTEM DETAYLARI
PRINCIPAL SECTIONS

